

HIRDAVAT GRUBU

HARDWARES



AŞINDIRICILAR
ABRASIVES

KESME ve TAŞLAMA TAŞLARI

- 1 Premium Qualitätsstufe
- 2 Material
- 3 Durchmesser x Stärke x Bohrung
- 4 Produktspezifikation
- 5 Maximale Umfangsgeschwindigkeit
- 6 Trennen oder Schruppen
- 7 Artikelnummer
- 8 OSA Zertifikat
- 9 Europäischer Standard



KESME TAŞLARI METAL / İNOX

CUTTING WHEELS

SCHNEIDERÄDER

ÜRÜN GÖRSELİ				
ÇAP (mm)	115	125	180	230
KALINLIK x DELİK ÇAPI (mm)	1,0x22,23	1,0x22,23	1,6x22,23	2,0x22,23
SPESİFİKASYON	A 60 R	A 60 R	A 46 R	A 36 R
KULLANIM ALANI	Aşındırıcıların çelik endüstrisinde oldukça geniş bir kullanım alanı bulunuyor; gemi yapımı, parça üretimi, otomotiv ve inşaat bileşenleri, özel profiller, borular, elektrikli ürünler, araç - gereç ve makinaların bakım ve tamiri.			

KESME TAŞLARI METAL / İNOX

CUTTING WHEELS

SCHNEIDERÄDER

ÜRÜN GÖRSELİ				
ÇAP (mm)	115	125	180	230
KALINLIK x DELİK ÇAPI (mm)	3,0x22,23	3,0x22,23	3,0x22,23 3,2x22,23	3,0x22,23 3,8x22,23 3,2x22,23
SPESİFİKASYON	A30 S	A30 S	A30 S	A30 S
KULLANIM ALANI	Aşındırıcıların çelik endüstrisinde oldukça geniş bir kullanım alanı bulunuyor; gemi yapımı, parça üretimi, otomotiv ve inşaat bileşenleri, özel profiller, borular, elektrikli ürünler, araç - gereç ve makinaların bakım ve tamiri.			

Değerler milimetre olarak verilmiştir.

Values are given in millimeters.

Werte sind in millimetern angegeben.

KESME TAŞLARI METAL / İNOX

CUTTING WHEELS

SCHNEIDERÄDER

ÜRÜN GÖRSELİ			
	115	180	230
ÇAP (mm)	115	180	230
KALINLIK x DELİK ÇAPI (mm)	1,0x22,23	2,0x22,23	1,9x22,23 2,0x22,23
SPESİFİKASYON	A 60 S	A 30 S	A 46 S A 30 S
KULLANIM ALANI	Aşındırıcıların çelik endüstrisinde oldukça geniş bir kullanım alanı bulunuyor; gemi yapımı, parça üretimi, otomotiv ve inşaat bileşenleri, özel profiller, borular, elektrikli ürünler, araç - gereç ve makinaların bakım ve tamiri.		

TAŞLAMA TAŞLARI METAL

CUTTING WHEELS

SCHNEIDERÄDER

ÜRÜN GÖRSELİ				
	115	125	180	230
ÇAP (mm)	115	125	180	230
KALINLIK x DELİK ÇAPI (mm)	6,0x22,23	6,0x22,23	6,0x22,23 8,0x22,23	6,0x22,23 8,0x22,23
SPESİFİKASYON	A 24 Q	A 24 Q	A 24 Q	A 24 Q
KULLANIM ALANI	Aşındırıcıların çelik endüstrisinde oldukça geniş bir kullanım alanı bulunuyor; gemi yapımı, parça üretimi, otomotiv ve inşaat bileşenleri, özel profiller, borular, elektrikli ürünler, araç - gereç ve makinaların bakım ve tamiri.			

TAŞLAMA TAŞLARI METAL / İNOX

CUTTING WHEELS

SCHNEIDERÄDER

ÜRÜN GÖRSELİ				
	115	125	180	230
ÇAP (mm)	115	125	180	230
KALINLIK x DELİK ÇAPI (mm)	6,4x22,23	6,4x22,23	6,4x22,23 8,0x22,23	6,4x22,23 8,0x22,23
SPESİFİKASYON	A 24 P A 30 P	A 30 P	A 24 P A 30 P	A 30 P
KULLANIM ALANI	Aşındırıcıların çelik endüstrisinde oldukça geniş bir kullanım alanı bulunuyor; gemi yapımı, parça üretimi, otomotiv ve inşaat bileşenleri, özel profiller, borular, elektrikli ürünler, araç - gereç ve makinaların bakım ve tamiri.			

Değerler milimetre olarak verilmiştir.

Values are given in millimeters.

Werte sind in millimetern angegeben.

ZIMPARALAR

Norton flap diskler; işlem süresini azaltan ve toplam ürün maliyetini düşüren, hafif talaş kaldırma, pah kırma, çapak giderme, kaynak dikişinin temizlenmesi ve finisaj işlemleri için tasarlanmıştır. Flap diskler; fiber disklere nazaran daha hızlı bir uygulama ve daha iyi bir yüzey finisajı sunar. Bunun yanı sıra, flap yapısı sayesinde daha uzun bir kullanım ömrü sağlar.

ZIMPARALAR

METAL / İNOX

FLAP DISCS

FLAMMSCHEIBEN

ÜRÜN GÖRSELİ		
ÇAP x DELİK (mm)	115 x 22	180 x 22
KUM	40 - 60 - 80	40 - 60 - 80
KULLANIM ALANI	Alüminyum oksit aşındırıcı dayanıklı flap disk. Uzun ömürlü ve düzgün finisaj sağlar	

ZIMPARALAR

METAL / İNOX

FLAP DISCS

FLAMMSCHEIBEN

ÜRÜN GÖRSELİ		
ÇAP x DELİK (mm)	115 x 22	180 x 22
KUM	40 - 60 - 80 - 120	40 - 60 - 80 - 120
KULLANIM ALANI	Çelik ve paslanmaz çeliğin çapağının giderilmesi ve kaba taşlama işlemleri için çok amaçlı ürün Kendiliğinden keskinleşen zirkonyum aşındırıcı mineral Orta ve düşük basınçta yüksek & düzenli kesme hızı Mükemmel fiyat & performans oranı	

A close-up photograph of a person's hands using a blue Bantlar tape dispenser to seal a cardboard box. The dispenser is a handheld tool with a large circular wheel and a cutting mechanism. The person is wearing a white tank top and a blue denim shirt. The background is a plain, light-colored wall. The text "BANTLAR" is overlaid in white, bold, uppercase letters on a dark blue rectangular background.

BANTLAR

TAPES

DERZ BANTLAR

JOINT TAPE

FUGENBAND

ÖLÇÜ DIMENSIONS MASSE	50MM*45M	50MM*90M	100MM*90M
AĞIRLIK WEIGHT GEWICHT	123	247	450
KULLANIM AMACI PURPOSE OF USAGE NUTZUNGSZWECK	<p>Alçı levha, duvar ve asma tavan sistemlerinin yapımında, ek yerlerinde çatlakları önlemek amacı ile kullanılan kendinden yapışkanlı cam elyaf banttır</p> <p>It is a self-adhesive glass fiber tape used in the construction of plasterboard, wall and suspended ceiling systems, to prevent cracks in the joints.</p> <p>Es ist ein selbstklebendes Glasfaserband, das beim Bau von Gipskarton-, W und abgehängten Deckensystemen verwendet wird, um Risse in den Fugen zu vermeiden.</p>		
TEKNİK ÖZELLİKLER TECHNICAL SPECIFICATIONS TECHNISCHE DATEN	<p>1x1 ölçüsünde 8*8 kare bulunur. (1 inch 25,4 mm) It has 8*8 square in 1x1 size. (1 inch 25,4 mm) Es hat 8*8 quadrat in 1x1 grösse. (1 Zoll 25,4 mm)</p> <p>Metrekare ağırlığı 50 gramdır. Weight of square meter is 50 grams. Gewicht des Quadratmeters ist 50 gramm.</p>		

ELEKTRİKÇİ BANTLARI

ELECTRICIAN BANDS

ELEKTRIKER-BANDS

RENK COLOUR FARBE	SİYAH BLACK SCHWARZ	KIRMIZI RED ROT	BEYAZ WHITE WEISS	MAVİ BLUE BLAU	SARI YELLOW GELB	GRİ GREY GRAU
MALZEME MATERIAL MATERIAL	<p>Kauçuk yapıştırıcı ile kaplanmış PVC film. PVC film coated with rubber adhesive. PVC-Folie mit Kautschukkleber beschichtet.</p>					
KULLANIM AMACI PURPOSE OF USAGE NUTZUNGSZWECK	<p>Elektrik, ısı, ses yalıtımı ve Split Klimaların boru yalıtımlarında kullanılır. Çeliğe yapışma mukavemeti 2,0 N/m.</p> <p>It is used in electricity, heat, sound insulation and pipe insulation of Split Air Conditioners. Adhesion strength to steel 2.0 N/m.</p> <p>Es wird in der Strom-, Wärme-, Schalldämmung und Rohrisolierung von Split-Klimaanlagen verwendet. Haftfestigkeit auf Stahl 2,0 N/m.</p>					

TEKNİK ÖLÇÜLERİ	TECHNICAL DIMENSIONS	TECHNISCHE ABMESSUNGEN
EN, WIDTH, BREITE	19 mm	
BOY, SIZE, GRÖSSE	10 YARDA = 9,14M	10 YARDS = 9,14M

Değerler milimetre olarak verilmiştir.

Values are given in millimeters.

Werte sind in millimetern angegeben.

YAPIŞKANLI KAPI PENCERE BANTLARI

ADHESIVE RUBBER WEATHERSTRIP

KLEBENDE GUMMI-DICHTSTREIFEN

ÇEŞİTLERİ TYPES TYPEN	İNCE THIN DÜNN	KALIN THICK
ÖLÇÜLERİ DIMENSIONS MASSE	8x5 mm	9x6 mm
TİP TYPE TYP	D Tip D Type D Typ	D Tip D Type D Typ
UZUNLUK LENGTH LÄNGE	100 M (50x2) = 1 Rulo 100 M (50x2) = 1 Roll 100 M (50x2) = 1 Rollen	100 M (50x2) = 1 Rulo 100 M (50x2) = 1 Roll 100 M (50x2) = 1 Rollen
AĞIRLIK (gram) WEIGHT (grams) GEWICHT (gramm)	1 KG/ Rulo 1 KG/ Roll 1 KG/ Rollen	1,3 KG/ Rulo 1,3 KG/ Roll 1,3 KG/ Rollen
RENK COLOUR FARBE	Beyaz White Weiss	Kahverengi Brown Braun
MALZEME MATERIAL MATERIAL	Kendinden yapışkanlı epdm köpük kauçuk. Self adhesive epdm foam rubber. Selbstklebendes epdm schaumgummi.	



Değerler milimetre olarak verilmiştir.

Values are given in millimeters.

Werte sind in millimetern angegeben.

KOLİ BANTLARI

DUCT TAPE

KLEBEBAND

ÇEŞİTLERİ TYPES TYPEN	AKRİLİK KOLİ BANDI ACRYLIC BOX TAPE KASTENBAND AUS ACRYL	HOTMELT KOLİ BANDI HOTMELT BOX TAPE KASTENKLEBEBAND HOTMELT
MALZEME MATERIAL MATERIAL	Tutkalanmış çift yönlü polipropilen film Glued duplex polypropylene film. Gelebte bidirektionale polypropylenfolie.	
KULLANIM AMACI PURPOSE OF USAGE NUTZUNGSZWECK	Plastik ve naylon yüzeylerde kullanılır. Used on plastic and nylon surfaces. Auf kunststoff und nylonoberflächen verwendet.	Karton kapatmada kullanılır. It is used for covering carton. Es wird zum abdecken von karton verwendet.

TEKNİK ÖZELLİKLER	TECHNICAL SPECIFICATIONS	TECHNISCHE DATEN
	EN, WIDTH, BREITE	45 mm
	BOY, SIZE, GRÖSSE	100 m

MASKELEME BANTLARI

MASKING TAPE

ABDECKBAND

ÇEŞİTLERİ TYPES TYPEN	HOTMELT MASKELEME	DOĞAL KAUÇUK MASKELEME
MALZEME MATERIAL MATERIAL	Kauçuk emdirilmiş kağıt bant. Rubber impressed paper tape. Gummigedrucktes papierband.	
KULLANIM AMACI PURPOSE OF USAGE NUTZUNGSZWECK	Boya, Otomotiv ve Mobilya/İnşaat sektörlerinde kullanılır. It is used in Paint, Automotive and Furniture/Construction sectors. Es wird in den Bereichen Farben, Automobil und Möbel/Bau eingesetzt.	

HOTMELT MASKELEME ÖLÇÜ TABLOSU / HOTMELT MASKING MEASUREMENT TABLE / MESSTABELLE FÜR HOTMELT-MASKING				
EN, WIDTH, BREITE	18mm	24mm	36mm	48mm
BOY, SIZE, GRÖSSE	25 m	25 m	25 m	25 m

DOĞAL KAUÇUK MASKELEME ÖLÇÜ TABLOSU / NATURAL RUBBER MASKING MEASUREMENT TABLE / NATURKAUÇUK-MASKING-MESSTABELLE				
EN, WIDTH, BREITE	18mm	24mm	36mm	48mm
BOY, SIZE, GRÖSSE	25 m	25 m	25 m	25 m

Değerler milimetre olarak verilmiştir.

Values are given in millimeters.

Werte sind in millimetern angegeben.

TEFLON BANTLAR

TEFLON TAPE

TEFLONBAND

ÖLÇÜ DIMENSIONS MASSE	12mm* 0,075mm* 10m	12mm* 0,075mm* 10m	
RENK COLOUR FARBE	BEYAZ WHITE WEISS	BEYAZ WHITE WEISS	
YOĞUNLUK INTENSITY INTENSITÄT	0,3 g/ cm ³	0,25 g/ cm ³	
NET AĞIRLIK NET WEIGHT REINGEWICHT	2,7 g	2,7 g	
DETAY DETAIL DETAIL	Yapışkan özelliği yoktur. Not adhesive. Nichtklebend.		



DÜZENLEYİCİLER
ORGANIZERS

Unterlegscheibe
M8
16mm

Unterlegscheibe
M10
20mm

Unterlegscheibe
M12
24mm

Federring
M10

Federring
M12

AVADANLIKLAR

STORAGE BINS

LAGERBEHÄLTER

ÜRÜN GÖRSELİ					
ÜRÜN ADI	Avadanlık				
ÇEŞİTLERİ	NO:1	NO:2	NO:3	NO:4	NO:5
RENK	Kırmızı, Mavi, Siyah	Kırmızı, Mavi, Siyah	Kırmızı, Mavi, Siyah	Kırmızı, Mavi, Siyah	Kırmızı, Mavi, Siyah
ÖLÇÜLERİ	(WxLxH) mm 82x100x52	(WxLxH) mm 165x100x82	(WxLxH) mm 230x153x125	(WxLxH) mm 335x210x165	(WxLxH) mm 505x320x200

AVADANLIK DOLAPLARI

STORAGE CABINETS

VLAGERSCHRÄNKE

ÜRÜN GÖRSELİ			
ÜRÜN ADI	Avadanlık Dolapları		
ÇEŞİTLERİ	Kapaklı Avadanlık Dolabı 1	Kapaklı Avadanlık Dolabı 2	Kapaklı Avadanlık Dolabı 3
ÖLÇÜLERİ	(WxLxH) mm 400x1600x900	(WxLxH) mm 260x1600x700	(WxLxH) mm 400x1600x900

ÇEKMECE MODÜLLERİ

DRAWER MODULES

SCHUBLADENMODULE

ÜRÜN GÖRSELİ		
ÜRÜN ADI	Hobby Set 1- 2- 3- 4- 5- 6	
ÇEŞİTLERİ	Kırmızı, Mavi, Siyah	
ÖLÇÜLERİ	(WxLxH) mm: 120x225x280 - 120x450x335 - 140x340x255 - 140x425x335 - 120x1 12x225 - 140x450x339	

Değerler milimetre olarak verilmiştir.

Values are given in millimeters.

Werte sind in millimetern angegeben.

MODÜLLER

MODULAR GROUP





MODULARE GRUPPE

ÜRÜN GÖRSELİ		
ÜRÜN ADI	Modüller	
ÇEŞİTLERİ	Gezer Döner Modül	Eksene Modül
ÖLÇÜLERİ	(WxLxH) mm 630x630x1150	(WxLxH) mm 840x970x1520 880x1010x1540 880x1010x1560

ORGANİZERLER

ORGANIZERS



VERANSTALTER

ÜRÜN GÖRSELİ	   			
ÜRÜN ADI	Polymax / Double			
ÇEŞİTLERİ	Poly max 32 Organizer	Poly Max 38 Organizer	Poly Max 48 Organizer	Poly Max Double Organizer
ÖLÇÜLERİ	(WxLxH) mm 270 x 330 x 60	(WxLxH) mm 210 x 389 x 67	(WxLxH) mm 373 x 470 x 80	(WxLxH) mm 270 x 320 x 60

ORGANİZERLER

ORGANIZERS

VERANSTALTER

ÜRÜN GÖRSELİ	  		
ÜRÜN ADI	Poly		
ÇEŞİTLERİ	Poly Organizer 1/8, 2/12, 3/8 Kırmızı, Mavi	Poly Organizer 32, 38, 48	Poly Organizer 31 / 16, 41 / 24, Set
ÖLÇÜLERİ	(WxLxH) mm 140x165x35, 155x265x40, 180x303x80	(WxLxH) mm 265x320x50, 300x380x60, 375x480x75	(WxLxH) mm 255x300x54, 370x400x58, 279x322x297

Değerler milimetre olarak verilmiştir.

Values are given in millimeters.

Werte sind in millimetern angegeben.



**ELEKTRİKLİ
EL ALETLERİ**
POWER TOOLS

12V 2.0AH LI-ION ÇİFT AKÜLÜ MATKAP

DCD710D2

Akü Voltajı	12V
Akü Tipi	Li-Ion
Akü Kapasitesi	2.0 Ah
Maksimum Tork (Yumuşak/Sert)	15 / 24 Nm
Yüksüz Hızı	0-400/1500 dev/dak.
Mandren Kapasitesi	1-10 mm
Maksimum Delme Kapasitesi [Ahşap / Metal]	20 / 10 mm
Ağırlık	1.1 kg
Uzunluk x Yükseklik	185 x 195 mm



12V 2.0AH LI-ION KÖMÜRSÜZ ÇİFT AKÜLÜ KOMPAKT MATKAP

DCD701D2

Akü Voltajı	12V
Akü Tipi	Li-ion
Akü Kapasitesi	2.0 Ah
Maksimum Tork (Yumuşak)	25.5 Nm
Maksimum Tork (Sert)	57.5 Nm
Yüksüz Hızı	0-425 / 0-1500 dev/dak.
Mandren Kapasitesi	10 mm
Maksimum Delme Kapasitesi (Ahşap)	20 mm
Maksimum Delme Kapasitesi (Metal)	10 mm
Ağırlık	1 kg (batarya hariç)
Uzunluk x Yükseklik	152 x 185 mm



12V 2.0AH LI-ION ÇİFT AKÜLÜ KÖMÜRSÜZ DARBELİ TORNAVİDA

DCF801D2

Akü Voltajı	12V
Akü Tipi	Li-ion
Akü Kapasitesi	2.0 Ah
Maksimum Tork	163 Nm
Yüksüz Hızı	0-950/1950/2850 dev/dak.
Darbe oranı	0-3600 dar/dak.
Uç Tutucu	6.35 mm
Ağırlık	0.8 kg (batarya hariç)
Uzunluk x Yükseklik	125 x 188 mm



Değerler milimetre olarak verilmiştir.

Values are given in millimeters.

Werte sind in millimetern angegeben.

18V 1.5AH LI-ION ÇİFT AKÜLÜ DARBESİZ MATKAP

DCD771S2

Akü Voltajı	18V
Akü Tipi	Li-ion
Akü Kapasitesi	1.5 Ah
Maksimum Tork (Sert)	42 Nm
Maksimum Tork (Yumuşak)	24 Nm
Yüksüz Hızı	0-450/1500 dev/dak.
Mandren Kapasitesi	1.5-13 mm
Maksimum Delme Kapasitesi [Ahşap / Metal]	30/13 mm
Ağırlık	1.65 kg
Uzunluk x Yükseklik	219 x 191 mm



18V 1.5AH LI-ION KÖMÜRSÜZ ÇİFT AKÜLÜ DARBESİZ MATKAP

DCD777S2T

Akü Voltajı	18V
Akü Tipi	Li-ion
Akü Kapasitesi	1.5 Ah
Maksimum Tork (Sert)	65 Nm
Maksimum Tork (Yumuşak)	26 Nm
Yüksüz Hızı	0-500/1750 dev/dak.
Mandren Kapasitesi	1.5-13 mm
Maksimum Delme Kapasitesi [Ahşap / Metal]	30/13 mm
Ağırlık	1.5 kg
Uzunluk x Yükseklik	192 x 198 mm



18V 2.0AH LI-ION KOMPAKT KÖMÜRSÜZ ÇİFT AKÜLÜ DARBESİZ MATKAP

DCD708D2T

Akü Voltajı	18V
Akü Tipi	Li-ion
Akü Kapasitesi	2.0 Ah
Maksimum Tork (Sert)	65 Nm
Maksimum Tork (Yumuşak)	26 Nm
Yüksüz Hızı	0-450/1650 dev/dak.
Mandren Kapasitesi	1.5-13 mm
Maksimum Delme Kapasitesi [Ahşap / Metal]	35/13 mm
Ağırlık	1.45 kg
Uzunluk x Yükseklik	160 x 198 mm



Değerler milimetre olarak verilmiştir.

Values are given in millimeters.

Werte sind in millimetern angegeben.

18V 2.0AH LI-ION KÖMÜRSÜZ ÇİFT AKÜLÜ DARBESİZ MATKAP

DCD800D2T

Akü Voltajı	18V
Akü Tipi	Li-ion
Akü Kapasitesi	2.0 Ah
Maksimum Tork (Yumuşak)	27 Nm
Maksimum Tork (Sert)	90 Nm
Yüksüz Hızı	0-650/ 0-2000 dev/dak.
Mandren Kapasitesi	13 mm
Maksimum Delme Kapasitesi (Ahşap)	55 mm
Maksimum Delme Kapasitesi (Metal)	13 mm
Ağırlık	1.28 kg (batarya hariç)
Uzunluk x Yükseklik	163,8 x 205,7 mm



18V 5.0AH LI-ION KÖMÜRSÜZ ÇİFT AKÜLÜ DARBESİZ MATKAP

DCD791P2

Akü Voltajı	18V
Akü Tipi	Li-ion
Akü Kapasitesi	5.0 Ah
Maksimum Tork (Sert)	70 Nm
Maksimum Tork (Yumuşak)	27 Nm
Yüksüz Hızı	0-550/2000 dev/dak.
Mandren Kapasitesi	1.5-13 mm
Maksimum Delme Kapasitesi [Ahşap / Metal]	40/13 mm
Ağırlık	1.72 kg
Uzunluk x Yükseklik	173 x 203 mm



18V 5.0AH LI-ION KÖMÜRSÜZ ÇİFT AKÜLÜ DARBESİZ MATKAP

DCD800P2T

Akü Voltajı	18V
Akü Tipi	Li-ion
Akü Kapasitesi	5.0 Ah
Maksimum Tork (Yumuşak)	27 Nm
Maksimum Tork (Sert)	90 Nm
Yüksüz Hızı	0-650/ 0-2000 dev/dak.
Mandren Kapasitesi	13 mm
Maksimum Delme Kapasitesi (Ahşap)	55 mm
Maksimum Delme Kapasitesi (Metal)	13 mm
Ağırlık	1.28 kg (batarya hariç)
Uzunluk x Yükseklik	163,8 x 205,7 mm



Değerler milimetre olarak verilmiştir.

Values are given in millimeters.

Werte sind in millimetern angegeben.

18V 1.5AH LI-ION ÇİFT AKÜLÜ DARBELİ MATKAP

DCD776S2

Akü Voltajı	18V
Akü Tipi	Li-Ion
Akü Kapasitesi	1.5 Ah
Maksimum Tork (Sert)	42 Nm
Maksimum Tork (Yumuşak)	24 Nm
Yüksüz Hızı	0-400/1500 dev/dak.
Darbe Oranı	0-7650/25500 dar/dak.
Mandren Kapasitesi	1.5-13 mm
Maks. Delme Kap. [Ahşap / Metal/ Duvar]	30/13/13 mm
Ağırlık	1.7 kg
Uzunluk x Yükseklik	228 x 191 mm



18V 2.0AH LI-ION KOMPAKT KÖMÜRSÜZ ÇİFT AKÜLÜ DARBELİ MATKAP

DCD709D2T

Akü Voltajı	18V
Akü Tipi	Li-Ion
Akü Kapasitesi	2.0 Ah
Maksimum Tork (Sert)	65 Nm
Maksimum Tork (Yumuşak)	26 Nm
Yüksüz Hızı	0-450/1650 dev/dak.
Darbe Oranı	0-28050 dar/dak.
Mandren Kapasitesi	1.5-13 mm
Maks. Delme Kap. [Ahşap / Metal/ Duvar]	30/13/13 mm
Ağırlık	1.5 kg
Uzunluk x Yükseklik	175 x 198 mm



18V 2.0AH LI-ION KÖMÜRSÜZ ÇİFT AKÜLÜ DARBELİ MATKAP

DCD796D2

Akü Voltajı	18V
Akü Tipi	Li-Ion
Akü Kapasitesi	2.0 Ah
Maksimum Tork (Sert)	70 Nm
Maksimum Tork (Yumuşak)	27 Nm
Yüksüz Hızı	0-550/2000 dev/dak.
Darbe Oranı	0-9350/34000 dar/dak.
Mandren Kapasitesi	1.5-13 mm
Maks. Delme Kap. [Ahşap / Metal/ Duvar]	40/13/13 mm
Ağırlık	1.60 kg
Uzunluk x Yükseklik	190 x 203 mm



Değerler milimetre olarak verilmiştir.

Values are given in millimeters.

Werte sind in millimetern angegeben.

18V 2.0AH LI-ION KÖMÜRSÜZ ÇİFT AKÜLÜ DARBELİ MATKAP

DCD805D2T

Akü Voltajı	18V
Akü Tipi	Li-ion
Akü Kapasitesi	2.0 Ah
Maksimum Tork (Yumuşak)	27 Nm
Maksimum Tork (Sert)	90 Nm
Yüksüz Hızı	0-650/ 0-2000 dev/dak.
Darbe Oranı	11.050/34.000 dar/dak.
Mandren Kapasitesi	13 mm
Maksimum Delme Kapasitesi (Ahşap)	55 mm
Maksimum Delme Kapasitesi (Metal)	13 mm
Maksimum Delme Kapasitesi (Duvar)	13 mm
Ağırlık	1.34 kg (batarya hariç)
Uzunluk x Yükseklik	177,8 x 205,7 mm



18V 1.7AH LI-ION POWER STACK KÖMÜRSÜZ ÇİFT AKÜLÜ DARBELİ MATKAP

DCD805E2T

Akü Voltajı	18V
Akü Tipi	Li-ion
Akü Kapasitesi	1.7 Ah Power Stack
Maksimum Tork (Yumuşak)	27 Nm
Maksimum Tork (Sert)	90 Nm
Yüksüz Hızı	0-650/ 0-2000 dev/dak.
Darbe Oranı	11.050 / 34.000 dar/dak.
Mandren Kapasitesi	13 mm
Maksimum Delme Kapasitesi (Ahşap)	55 mm
Maksimum Delme Kapasitesi (Metal)	13 mm
Maksimum Delme Kapasitesi (Duvar)	13 mm
Ağırlık	1.34 kg (batarya hariç)
Uzunluk x Yükseklik	177,8 x 205,7 mm



DEWALT POWER STACK



18V 5.0AH LI-ION KÖMÜRSÜZ ÇİFT AKÜLÜ DARBELİ MATKAP

DCD796P2

Akü Voltajı	18V
Akü Tipi	Li-Ion
Akü Kapasitesi	5.0 Ah
Maksimum Tork (Sert)	70 Nm
Maksimum Tork (Yumuşak)	27 Nm
Yüksüz Hızı	0-550/2000 dev/dak.
Darbe Oranı	0-9350/34000 dar/dak.
Mandren Kapasitesi	1.5-13 mm
Maks. Delme Kap. [Ahşap / Metal/ Duvar]	40/13/13 mm
Ağırlık	1.82 kg
Uzunluk x Yükseklik	190 x 203 mm



Değerler milimetre olarak verilmiştir.

Values are given in millimeters.

Werte sind in millimetern angegeben.

18V 5.0AH LI-ION KÖMÜRSÜZ ÇİFT AKÜLÜ DARBELİ MATKAP

DCD805P2T

Akü Voltajı	18V
Akü Tipi	Li-ion
Akü Kapasitesi	5.0 Ah
Maksimum Tork (Yumuşak)	27 Nm
Maksimum Tork (Sert)	90 Nm
Yüksüz Hızı	0-650/ 0-2000 dev/dak.
Darbe Oranı	11.050 / 34.000 dar/dak.
Mandren Kapasitesi	13mm
Maksimum Delme Kapasitesi (Ahşap)	55mm
Maksimum Delme Kapasitesi (Metal)	13mm
Maksimum Delme Kapasitesi (Duvar)	13mm
Ağırlık	1.34 kg (batarya hariç)
Uzunluk x Yükseklik	177,8 x 205,7 mm



18V 2.0AH LI-ION KÖMÜRSÜZ ÇİFT AKÜLÜ DARBELİ TORNAVİDA

DCF887D2

Akü Voltajı	18V
Akü Tipi	Li-ion
Akü Kapasitesi	2.0 Ah
Maksimum Tork	205 Nm
Yüksüz Hızı	0-1000/2800/3250 dev/dak.
Darbe Oranı	0 - 3800 dar/dak.
Maksimum Somun Çapı	M14
Uç Tutucu	6.35 mm (1/4")
Ağırlık	1.35 kg
Uzunluk x Yükseklik	134 x 245 mm



18V 2.0AH LI-ION KÖMÜRSÜZ ÇİFT AKÜLÜ DARBELİ TORNAVİDA

DCF850D2T

Akü Voltajı	18V
Akü Tipi	Li-ion
Akü Kapasitesi	2.0 Ah
Maksimum Tork	206 Nm
Yüksüz Hızı	0-1.000/2.800/3.250 dev/dak.
Darbe Oranı	0-3800 dar/dak.
Uç Tutucu	6.35 mm
Ağırlık	0,9 kg (batarya hariç)
Uzunluk x Yükseklik	101 x 210 mm



Değerler milimetre olarak verilmiştir.

Values are given in millimeters.

Werte sind in millimetern angegeben.

18V 5.0AH LI-ION KÖMÜRSÜZ ÇİFT AKÜLÜ DARBELİ TORNAVİDA

DCF887P2

Akü Voltajı	18V
Akü Tipi	Li-Ion
Akü Kapasitesi	5.0 Ah
Maksimum Tork	205 Nm
Yüksüz Hızı	0-1000/2800/3250 dev/dak.
Darbe Oranı	0 - 3800 dar/dak.
Maksimum Somun Çapı	M14
Uç Tutucu	6.35 mm (1/4")
Ağırlık	1.52 kg
Uzunluk x Yükseklik	134 x 245 mm



18V 5.0AH LI-ION KÖMÜRSÜZ ÇİFT AKÜLÜ DARBELİ TORNAVİDA

DCF850P2T

Akü Voltajı	18V
Akü Tipi	Li-ion
Akü Kapasitesi	5.0 Ah
Maksimum Tork	192 Nm
Yüksüz Hızı	0-3200 dev/dak.
Uç Tutucu	6.35 mm
Darbe Oranı	0-4200 dar/dak.
Ağırlık	0,88 kg (batarya hariç)
Uzunluk x Yükseklik	129mm X 210 mm



18V 4.0AH 125MM LI-ION ÇİFT AKÜLÜ AVUÇ TAŞLAMA

DCG412M2

Akü Voltajı	18V
Akü Tipi	Li-Ion
Akü Kapasitesi	4.0 Ah
Disk Çapı	125 mm
Mil Bağlantısı	M14
Tetik Tipi	Alttan Tetik
Yüksüz Hızı	7000 dev/dak.
Ağırlık	2.5 kg
Uzunluk x Yükseklik	400 x 125 mm



Değerler milimetre olarak verilmiştir.

Values are given in millimeters.

Werte sind in millimetern angegeben.

18V 1.7AH LI-ION POWER STACK KÖMÜRSÜZ ÇİFT AKÜLÜ DARBELİ TORNAV

DCF850E2T-QW

Akü Voltajı	18V
Akü Tipi	Li-ion
Akü Kapasitesi	1.7 Ah Power Stack
Maksimum Tork (Yumuşak)	206 Nm
Yüksüz Hızı	0 - 1.000 / 2.800 / 3.250 dev/dak.
Darbe Oranı	0-3800 dar/dak.
Uç Tutucu	6.35 mm
Ağırlık	0,9 kg (batarya hariç)
Uzunluk x Yükseklik	101 x 210 mm



DEWALT POWER STACK



18V 3.0AH LI-ION KOMPAKT KÖMÜRSÜZ ÇİFT AKÜLÜ DARBELİ TORNAVİDA

DCF809L2T

Akü Voltajı	18V
Akü Tipi	Li-Ion
Akü Kapasitesi	3.0 Ah
Maksimum Tork	190 Nm
Yüksüz Hızı	0-2800 dev/dak.
Darbe Oranı	0 - 3200 dar/dak.
Maksimum Somun Çapı	M12
Uç Tutucu	6.35 mm (1/4")
Ağırlık	1.25 kg
Uzunluk x Yükseklik	130 x 236 mm



18V 2.0AH LI-ION KOMPAKT KÖMÜRSÜZ ÇİFT AKÜLÜ DARBELİ TORNAVİDA

DCF840D2T

Akü Voltajı	18V
Akü Tipi	Li-ion
Akü Kapasitesi	2.0 Ah
Maksimum Tork	192 Nm
Yüksüz Hızı	0-3200 dev/dak.
Uç Tutucu	6.35 mm
Darbe Oranı	0-4200 dar/dak.
Ağırlık	0,88 kg (batarya hariç)
Uzunluk x Yükseklik	129mm X 210 mm



Değerler milimetre olarak verilmiştir.

Values are given in millimeters.

Werte sind in millimetern angegeben.

18V 6.0AH 125MM LI-ION FLEXVOLT ADV. AVUÇ TAŞLAMA

DCG409T1

Akü Voltajı	18V
Akü Tipi	Li-ion
Akü Kapasitesi	6.0 Ah
Disk Çapı	125 mm
Mil Bağlantısı	M14
Tetik Tipi	Yandan Tetik
Yüksüz Hızı	9000 dev/dak.
Ağırlık	1,81 kg
Uzunluk x Yükseklik	382,09 x 130,025 mm



18V 4.0AH LI-ION KÖMÜRSÜZ SDS-PLUS PNÖMATİK MATKAP

DCH133M1

Akü Voltajı	18V
Akü Tipi	Li-Ion
Akü Kapasitesi	4.0 Ah
Uç Tutucu	SDS-Plus
Maksimum Darbe Gücü	2.8 J
Darbe Gücü (EPTA 05/2009)	2.6 J
Yüksüz Hızı	0-1500 dev/dak.
Darbe Oranı	0-5500 dar/dak.
Optimum Delme Kapasitesi [Betonda]	4-14 mm
Maks. Delme Kap. [Beton/ Ahşap / Metal]	26/30/13 mm
Keski / Oyma Modu	Evet
Ağırlık	2.9 kg
Uzunluk x Yükseklik	383 x 161 mm
Vibrasyon Değeri	14.5 m/s ²



18V 4.0AH LI-ION ÇİFT AKÜLÜ SDS-PLUS PNÖMATİK MATKAP

DCH253M2

Akü Voltajı	18V
Akü Tipi	Li-Ion
Akü Kapasitesi	4.0 Ah
Uç Tutucu	SDS-Plus
Maksimum Darbe Gücü	2.4 J
Darbe Gücü (EPTA 05/2009)	2.1 J
Yüksüz Hızı	0-1200 dev/dak.
Darbe Oranı	0-4500 dar/dak.
Optimum Delme Kapasitesi [Betonda]	4-12 mm
Maks. Delme Kap. [Beton/ Ahşap / Metal]	24/26/13 mm
Keski / Oyma Modu	Evet
Ağırlık	3.1 kg
Uzunluk x Yükseklik	301 x 202 mm
Vibrasyon Değeri	6.6 m/s ²



Değerler milimetre olarak verilmiştir.

Values are given in millimeters.

Werte sind in millimetern angegeben.

550W 10MM DARBESİZ MATKAP

DWD014S

Giriş Gücü	550W
Mandren Kapasitesi	10 mm
Yüksüz Hızı	0-2800 dev/dak.
Maksimum Tork	7.9 Nm
Maksimum Delme Kapasitesi [Ahşap]	25 mm
Maksimum Delme Kapasitesi [Metal]	10 mm
Mil Bağlantısı	1/2" x 20 U.N.F
Ağırlık	1.34 kg
Uzunluk x Yükseklik	225 x 170 mm



701W 10MM DARBESİZ MATKAP

DWD112S

Giriş Gücü	701W
Mandren Kapasitesi	10 mm
Yüksüz Hızı	0-2500 dev/dak.
Maksimum Tork	10.9 Nm
Maksimum Delme Kapasitesi [Ahşap]	25 mm
Maksimum Delme Kapasitesi [Metal]	10 mm
Mil Bağlantısı	1/2" x 20 U.N.F
Ağırlık	1.8 kg
Uzunluk x Yükseklik	230 x 190 mm



701W 13MM DARBELİ MATKAP

DWD024

Giriş Gücü	750W
Mandren Kapasitesi	13 mm
Yüksüz Hızı	0-2800 dev/dak.
Darbe Oranı	47600 dar/dak.
Maksimum Tork	8.6 Nm
Maksimum Delme Kapasitesi [Ahşap]	25 mm
Maksimum Delme Kapasitesi [Metal]	13 mm
Maksimum Delme Kapasitesi [Beton]	16 mm
Ağırlık	1.82 kg
Uzunluk x Yükseklik	255 x 180 mm



Değerler milimetre olarak verilmiştir.

Values are given in millimeters.

Werte sind in millimetern angegeben.

710W 3/4" SOMUN SIKMA MAKİNESİ

DW294

Giriş Gücü	710W
Maksimum Tork	440 Nm
Yüksüz Hızı	2200 dev/dak.
Darbe Oranı	2700 dar/dak.
Ağırlık	3.2 kg
Uzunluk x Yükseklik	292 x 216 mm



800W 26MM 3.0J SDS-PLUS PNÖMATİK MATKAP

D25133K

Giriş Gücü	800W
Maksimum Darbe Gücü	2.8 J
Darbe Gücü (EPTA 05/2009)	2.6 J
Yüksüz Hızı	0-1500 dev/dak.
Darbe Oranı	0-5500 dar/dak.
Optimum Delme Kapasitesi [Beton]	4-14 mm
Maksimum Delme Kapasitesi [Beton]	26 mm
Maks. Delme Kap. [Buat / Ahşap / Metal]	50/30/13 mm
Çalışma Modu	Kırma / Darbeli Delme / Delme
Ağırlık	2.6 kg
Uzunluk x Yükseklik	335 x 210 mm
Vibrasyon Değeri	15.4 m/s ²



900W 28MM 3.0J SDS-PLUS PNÖMATİK MATKAP

D25143K

Giriş Gücü	900W
Maksimum Darbe Gücü	3.2 J
Darbe Gücü (EPTA 05/2009)	3.0 J
Yüksüz Hızı	0-1450 dev/dak.
Darbe Oranı	0-5350 dar/dak.
Optimum Delme Kapasitesi [Beton]	4-18 mm
Maksimum Delme Kapasitesi [Beton]	28 mm
Maks. Delme Kap. [Buat / Ahşap / Metal]	65/30/13 mm
Çalışma Modu	Kırma / Darbeli Delme / Delme
Ağırlık	3.0 kg
Uzunluk x Yükseklik	340 x 210 mm
Vibrasyon Değeri	14.9 m/s ²



Değerler milimetre olarak verilmiştir.

Values are given in millimeters.

Werte sind in millimetern angegeben.

950W 30MM 3.5J SDS-PLUS PNÖMATİK MATKAP

D25334K

Giriş Gücü	950W
Maksimum Darbe Gücü	4.2 J
Darbe Gücü (EPTA 05/2009)	3.5 J
Yüksüz Hızı	0-1150 dev/dak.
Darbe Oranı	0-5200 dar/dak.
Optimum Delme Kapasitesi [Beton]	6-20 mm
Maksimum Delme Kapasitesi [Beton]	30 mm
Maks. Delme Kap. [Buat / Ahşap / Metal]	65/30/13 mm
Çalışma Modu	Kırma / Darbeli Delme / Delme
Ağırlık	3.9 kg
Uzunluk x Yükseklik	375 x 250 mm
Vibrasyon Değeri	6.9 m/s ²



730W 115MM NO-VOLT AVUÇ TAŞLAMA

DWE4016

Giriş Gücü	730W
Disk Çapı	115 mm
Tetik Tipi	Yandan Tetik
Yüksüz Hızı	11000 dev/dak.
Mil Bağlantısı	M14
Ağırlık	2.0 kg
Uzunluk x Yükseklik	270 x 80 mm



800W 115MM NO-VOLT AVUÇ TAŞLAMA

DWE4056

Giriş Gücü	800W
Disk Çapı	115 mm
Tetik Tipi	Yandan Tetik
Yüksüz Hızı	11800 dev/dak.
Mil Bağlantısı	M14
Ağırlık	1.8 kg
Uzunluk x Yükseklik	270 x 80 mm



Değerler milimetre olarak verilmiştir.

Values are given in millimeters.

Werte sind in millimetern angegeben.

900W 115MM NO-VOLT AVUÇ TAŞLAMA

DWE4156

Giriş Gücü	900W
Disk Çapı	115 mm
Tetik Tipi	Yandan Tetik
Yüksüz Hızı	11800 dev/dak.
Mil Bağlantısı	M14
Ağırlık	2.0 kg
Uzunluk x Yükseklik	270 x 80 mm



1400W 125MM NO-VOLT AVUÇ TAŞLAMA

DWE4237

Giriş Gücü	1400W
Disk Çapı	125 mm
Tetik Tipi	Yandan Tetik
Yüksüz Hızı	11500 dev/dak.
Mil Bağlantısı	M14
Ağırlık	2.2 kg
Uzunluk x Yükseklik	285 x 80 mm



2200W 180MM BÜYÜK TAŞLAMA

DWE493

Giriş Gücü	2200W
Disk Çapı	180 mm
Tetik Tipi	Alttan Tetik
Yüksüz Hızı	8500 dev/dak.
Mil Bağlantısı	M14
Ağırlık	5.1 kg
Uzunluk x Yükseklik	484 x 112 mm



Değerler milimetre olarak verilmiştir.

Values are given in millimeters.

Werte sind in millimetern angegeben.

2600W 180MM BÜYÜK TAŞLAMA

DWE497

Giriş Gücü	2600W
Disk Çapı	180 mm
Tetik Tipi	Alttan Tetik
Yüksüz Hızı	8500 dev/dak.
Mil Bağlantısı	M14
Ağırlık	5.4 kg
Uzunluk x Yükseklik	490 x 145 mm



2200W 230MM BÜYÜK TAŞLAMA

DWE492

Giriş Gücü	2200W
Disk Çapı	230 mm
Tetik Tipi	Alttan Tetik
Yüksüz Hızı	6600 dev/dak.
Mil Bağlantısı	M14
Ağırlık	5.2 kg
Uzunluk x Yükseklik	490 x 151 mm



2400W 230MM BÜYÜK TAŞLAMA

DWE4559

Giriş Gücü	2400W
Disk Çapı	230 mm
Tetik Tipi	Alttan Tetik
Yüksüz Hızı	6500 dev/dak.
Mil Bağlantısı	M14
Ağırlık	5.7 kg
Uzunluk x Yükseklik	520 x 145 mm



2600W 230MM BÜYÜK TAŞLAMA

DWE4579

Giriş Gücü	2600W
Disk Çapı	230 mm
Tetik Tipi	Alttan Tetik
Yüksüz Hızı	6500 dev/dak.
Mil Bağlantısı	M14
Aşırı Yük Koruması	Evet
Ağırlık	5.9 kg
Uzunluk x Yükseklik	520 x 145 mm



1500W 190MM DAİRE TESTERE

DWE5615

Giriş Gücü	1500W
Yüksüz Hızı	5500 dev/dak.
Bıçak Çapı	190 mm
Bıçak Göbek Çapı	30 mm
Maksimum Kesme Derinliği 90°	68 mm
Maksimum Kesme Derinliği 45°	48 mm
Ağırlık	4.0 kg



1750W 235X30MM DAİRE TESTERE

D23700

Giriş Gücü	1750W
Yüksüz Hızı	4700 dev/dak.
Bıçak Çapı	235 mm
Bıçak Göbek Çapı	30 mm
Maksimum Kesme Derinliği 90°	86 mm
Maksimum Kesme Derinliği 45°	62 mm
Ağırlık	8.2 kg
Uzunluk x Yükseklik	430 x 290 mm



Değerler milimetre olarak verilmiştir.

Values are given in millimeters.

Werte sind in millimetern angegeben.

18V 2.0AH V20 LİTYUM ÇİFT AKÜLÜ KÖMÜRSÜZ DARBELİ MATKAP

SBD715D2K

Akü Voltajı	18V
Akü Tipi	V20 Li-ion
Akü Kapasitesi	1.5 Ah
Maksimum Tork	60 Nm
Yüksüz Hızı	0-600/1900 dev/dak.
Mandren Kapasitesi	13 mm
Maks. Delme Kapasitesi (Ahşap)	35 mm
Maks. Delme Kapasitesi (Metal)	13 mm
Koli Adedi	3
Ağırlık	1.2 kg (batarya hariç)

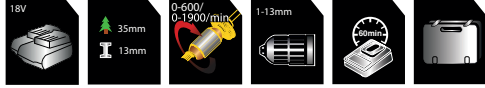

V20
LITHIUM ION

18V 2.0AH V20 LİTYUM ÇİFT AKÜLÜ DARBELİ MATKAP

SCD718D2K

Akü Voltajı	18V
Akü Tipi	V20 Li-ion
Akü Kapasitesi	2.0 Ah
Maksimum Tork	50 Nm
Yüksüz Hızı	0-400/1.500 dev/dak.
Mandren Kapasitesi	13 mm
Maks. Delme Kapasitesi (Ahşap)	35 mm
Maks. Delme Kapasitesi (Metal)	13 mm
Koli Adedi	3
Ağırlık	1.3 kg (batarya hariç)

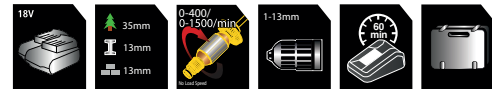

V20
LITHIUM ION

18V V20 KÖMÜRSÜZ DARBELİ MATKAP (AKÜSÜZ)

SBD715B

Akü Voltajı	18V
Akü Tipi	V20 Li-ion
Akü Kapasitesi	Aküsüz
Darbe Oranı	0-32300 dar/dak.
Maksimum Tork (sert)	60 nm
Yüksüz Hızı	0-600/0-1.900 dev/dak.
Mandren Kapasitesi	13mm
Maks. Delme Kapasitesi (Ahşap)	30 mm
Maks. Delme Kapasitesi (Metal)	13 mm
Maks. Delme Kapasitesi (Duvar)	13 mm
Ağırlık	1.5 kg



V20
LITHIUM ION

Değerler milimetre olarak verilmiştir.

Values are given in millimeters.

Werte sind in millimetern angegeben.

18V 1.5AH V20 LİTYUM ÇİFT AKÜLÜ KÖMÜRSÜZ DARBESİZ MATKAP

SBD710C2K

Akü Voltajı	18V
Akü Tipi	V20 Li-ion
Akü Kapasitesi	1.5 Ah
Maksimum Tork	60 Nm
Yüksüz Hızı	0-600/1900 dev/dak.
Mandren Kapasitesi	13 mm
Maks. Delme Kapasitesi (Ahşap)	35 mm
Maks. Delme Kapasitesi (Metal)	13 mm
Koli Adedi	3
Ağırlık	1.2 kg (batarya hariç)

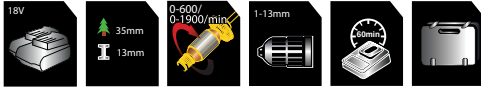

V20
LITHIUM ION

18V 1.5AH V20 LİTYUM ÇİFT AKÜLÜ KÖMÜRSÜZ DARBELİ MATKAP

SBD715C2K

Akü Voltajı	18V
Akü Tipi	V20 Li-ion
Akü Kapasitesi	1.5 Ah
Maksimum Tork	60 Nm
Yüksüz Hızı	0-600 / 0-1.900 dev/dak.
Mandren Kapasitesi	13 mm
Maks. Delme Kapasitesi (Ahşap)	30 mm
Maks. Delme Kapasitesi (Metal)	13 mm
Maks. Delme Kapasitesi (Duvar)	13 mm
Koli Adedi	3
Ağırlık	1.2 kg (batarya hariç)

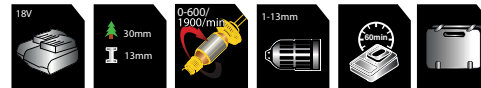

V20
LITHIUM ION

18V 1.5AH V20 LİTYUM ÇİFT AKÜLÜ DARBELİ MATKAP

SCD711C2K

Akü Voltajı	18V
Akü Tipi	V20 Li-ion
Akü Kapasitesi	1.5 Ah
Maksimum Tork	50 Nm
Yüksüz Hızı	0 - 400 / 1.500 dev/dak.
Mandren Kapasitesi	13 mm
Maks. Delme Kapasitesi (Ahşap)	35 mm
Maks. Delme Kapasitesi (Metal)	13 mm
Koli Adedi	3
Ağırlık	1.3 kg (batarya hariç)

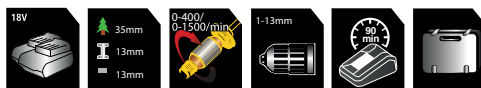

V20
LITHIUM ION

Değerler milimetre olarak verilmiştir.

Values are given in millimeters.

Werte sind in millimetern angegeben.

18V 2.0AH V20 LİTYUM ÇİFT AKÜLÜ DARBESİZ MATKAP

SCD700D2K

Akü Voltajı	18V
Akü Tipi	V20 Li-ion
Akü Kapasitesi	2.0 Ah
Maksimum Tork	50 Nm
Yüksüz Hızı	0-400 /1.500 dev/dak.
Mandren Kapasitesi	13 mm
Maks. Delme Kapasitesi (Ahşap)	35 mm
Maks. Delme Kapasitesi (Metal)	13 mm
Koli Adedi	4
Ağırlık	1.2 kg (batarya hariç)



V20
LITHIUM ION

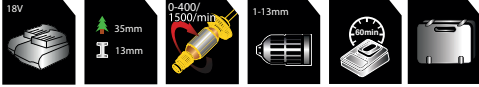

1600W 190MM DAİRE TESTERE

SC16

Giriş Gücü	1600 W
Yüksüz Hızı	5500 dev/dak
Testere Çapı	190 mm
Testere Delik Çapı	20/30 mm
Açı Kapasitesi	45°
Maks. Kesme Kapasitesi 90°	65 mm
Maks. Kesme Kapasitesi 45°	50 mm
Koli Adedi	2
Ağırlık	3.9 kg



1650W 254MM GÖNYE TESTERE

SM16

Giriş Gücü	1650W
Yüksüz Hızı	4800 dev/dak.
Bıçak Kalınlığı	2.8 mm
Bıçak Çapı	254 X 30 mm
Gönye Kapasitesi (sağ/sol)	52°/47°
Eğim Kapasitesi (sağ/sol)	0°/45°
Koli Adedi	1
Ağırlık	10.5 kg

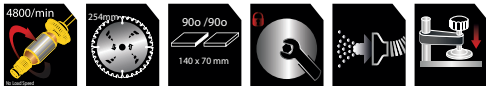

Değerler milimetre olarak verilmiştir.

Values are given in millimeters.

Werte sind in millimetern angegeben.

1800W 254MM GÖNYE TESTERE

SM18

Giriş Gücü	1800W
Yüksüz Hızı	4800 dev/dak
Bıçak Kalınlığı	2.8 mm
Bıçak Çapı	254 X 30 mm
Gönye Kapasitesi (sağ/sol)	52°/47°
Eğim Kapasitesi (sağ/sol)	45°/45°
Koli Adedi	1
Ağırlık	18.6 kg

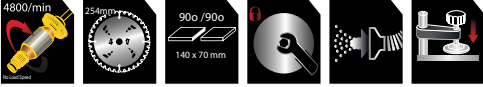

1200W 32CM ÇİM KESME MAKİNESİ

BEMW451

Güç	1200W
Kesme Geniřliđi	32cm
Çim Toplama Kapasitesi	35L
Yüksüz Hız	3500 dev/dak.
Ağırlık	9.35kg



1200W 32CM ÇİM KESME MAKİNESİ

BEMW451BH

Güç	1200 W
Kesme Geniřliđi	32cm
Çim Toplama Kapasitesi	35L
Yüksüz Hız	3500 dev/dak



Deđerler milimetre olarak verilmiřtir.

Values are given in millimeters.

Werte sind in millimetern angegeben.

1400W 34CM ÇİM KESME MAKİNESİ

BEMW461BH

Güç	1400 W
Kesme Geniřliđi	34cm
Çim Toplama Kapasitesi	40L
Yüksüz Hız	3500 dev/dak



1600W 38CM ÇİM KESME MAKİNESİ

BEMW471BH

Güç	1600 W
Kesme Geniřliđi	38cm
Çim Toplama Kapasitesi	45L
Yüksüz Hız	3500 dev/dak





**HALAT
BAĞLANTI
ELEMENLARI**

ROPE CONNECTION
ELEMENTS

STD HALAT BAĞLANTI ELEMANLARI

RIGGING

TAKELWERK

ÜRÜN TANIMI PRODUCT DESCRIPTION PRODUKTBESCHREIBUNG	ERKEK AYBOLT EYE BOLT RINGSCHRAUBE													
ÜRÜN GÖRSELİ PRODUCT IMAGE PRODUKTBILD														
MALZEME MATERIAL	Q235B													
KAPLAMA COVERING ABDECKUNG	Elektro Galvaniz													
ÖLÇÜLERİ DIMENSIONS MASSE	M6	M8	M10	M12	M14	M16	M18	M20	M22	M24	M27	M30	M33	M36
AĞIRLIK (gram) WEIGHT (grams) GEWICHT (gramm)	60	60	115	180	180	290	290	430	430	880	880	1650	1650	2600

STD HALAT BAĞLANTI ELEMANLARI

RIGGING

TAKELWERK

ÜRÜN TANIMI PRODUCT DESCRIPTION PRODUKTBESCHREIBUNG	Dişi AYBOLT EYE NUT AUGENMUTTER													
ÜRÜN GÖRSELİ PRODUCT IMAGE PRODUKTBILD														
MALZEME MATERIAL	Q235B													
KAPLAMA COVERING ABDECKUNG	ELEKTRO GALVANİZ													
ÖLÇÜLERİ DIMENSIONS MASSE	M6	M8	M10	M12	M14	M16	M18	M20	M22	M24	M27	M30	M33	M36
AĞIRLIK (gram) WEIGHT (grams) GEWICHT (gramm)	55	55	85	150	150	250	250	340	485	740	700	1400	1400	2200

Değerler milimetre olarak verilmiştir.

Values are given in millimeters.

Werte sind in millimetern angegeben.

STD HALAT BAĞLANTI ELEMANLARI

RIGGING

TAKELWERK

ÜRÜN TANIMI PRODUCT DESCRIPTION PRODUKTBESCHREIBUNG	GERDİRME/ ÇEKTİRME TURNBUCKLE SPANNSCHLOSS							
ÜRÜN GÖRSELİ PRODUCT IMAGE PRODUKTBILD								
MALZEME MATERIAL MATERIAL	Q235B							
KAPLAMA COVERING ABDECKUNG	Elektro Galvaniz							
ÖLÇÜLERİ DIMENSIONS MASSE	M6	M8	M10	M12	M16	M20	M22	M24
AĞIRLIK (gram) WEIGHT (grams) GEWICHT (gramm)	52	95	165	275	655	1200	1700	2200

STD HALAT BAĞLANTI ELEMANLARI

RIGGING

TAKELWERK

ÜRÜN TANIMI PRODUCT DESCRIPTION PRODUKTBESCHREIBUNG	A TİPİ KLEMENS A-TYPE WIRE ROPE CLIP DRAHTSEILKLEMME TYP A								KLEMENS WIRE ROPE CLIP DRAHTSEILKLEMME							
ÜRÜN GÖRSELİ PRODUCT IMAGE PRODUKTBILD																
MALZEME MATERIAL	Q235B								Q235B							
KAPLAMA COVERING ABDECKUNG	Elektro Galvaniz								Elektro Galvaniz							
ÖLÇÜLERİ DIMENSIONS MASSE	M6	M8	M10	M12	M15	M18	M20	M22	M6	M8	M10	M12	M14	M16	M19	M22
AĞIRLIK (gram) WEIGHT (grams) GEWICHT (gramm)	20	30	65	130	208	270	395	575	14,7	26	52	105	120	170	220	340

Değerler milimetre olarak verilmiştir.



Values are given in millimeters.

Werte sind in millimetern angegeben.

STD HALAT BAĞLANTI ELEMANLARI

RIGGING

TAKELWERK

ÜRÜN TANIMI PRODUCT DESCRIPTION PRODUKTBESCHREIBUNG	KARABİNA SPRING SNAP HOOK FEDERKARABINERHAKEN							VİDALI KARABİNA SPRING SNAP HOOK WITH SCREW FEDERKARABINERHAKEN MIT SCHRAUBE						
ÜRÜN GÖRSELİ PRODUCT IMAGE PRODUKTBILD														
MALZEME MATERIAL	Q195							Q195						
KAPLAMA COVERING ABDECKUNG	Elektro Galvaniz							Elektro Galvaniz						
ÖLÇÜLERİ DIMENSIONS MASSE	M5	M6	M7	M8	M10	M11	M12	M5	M6	M8	M10	M11	M12	
AĞIRLIK (gram) WEIGHT (grams) GEWICHT (gramm)	14,5	25,5	41	60	120	175	246	16,5	28	64	124	180	254	

STD HALAT BAĞLANTI ELEMANLARI

RIGGING

TAKELWERK

ÜRÜN TANIMI PRODUCT DESCRIPTION PRODUKTBESCHREIBUNG	ZİNCİR KİLİDİ EUROPEAN TYPE SHACKLE EUROPÄISCHER TYP SCHÄKEL							
ÜRÜN GÖRSELİ PRODUCT IMAGE PRODUKTBILD								
MALZEME MATERIAL MATERIAL	Q235B							
KAPLAMA COVERING ABDECKUNG	Elektro Galvaniz							
ÖLÇÜLERİ DIMENSIONS MASSE	M6	M8	M10	M12	M16	M20	M22	M24
AĞIRLIK (gram) WEIGHT (grams) GEWICHT (gramm)	22	48	88	170	400	780	1100	1650

Değerler milimetre olarak verilmiştir.

Values are given in millimeters.

Werte sind in millimetern angegeben.

A construction site at sunset. A large crane is silhouetted against the bright orange and yellow sky. The foreground and middle ground are filled with a dense network of scaffolding and rebar structures, illuminated by the warm light of the setting sun. The overall scene conveys a sense of active construction and industrial activity.

İNŞAAT MALZEMELERİ

CONSTRUCTION
MATERIALS

ÇATI SEMERLERİ

ROOF SADDLES

DACHSATTELE

ÖLÇÜLERİ DIMENSIONS MASSE	20x45mm	42x45mm
AĞIRLIK (gram) WEIGHT (grams) GEWICHT (gramm)	4,44	
RENK COLOUR FARBE	RAL 9002, RAL 3004, RAL 3009, RAL 6020	
DETAY DETAIL DETAIL	<p>Çatı Semeri, montaj sırasında malzemenin zarar görmesini engeller. Vida deliğinden su sızdırma olasılığını ortadan kaldırır.</p> <p>The Roof Saddle prevents the material from being damaged during assembly. It eliminates the possibility of water leaking from the screw hole.</p> <p>Der Dachsattel verhindert, dass das Material bei der Montage beschädigt wird. Es eliminiert die Möglichkeit, dass Wasser aus dem Schraubenloch austritt.</p>	
		

ÇİROZLAR

DISTANCE PIECES

DISTANZSTÜCKE

AĞIRLIK (grams) WEIGHT (grams) GEWICHT(grams)	400	
TABLA KALINLIĞI TABLE THICKNESS TISCHDICKE	3mm-4mm	
U DEMİRİ KALINLIĞI U BAR THICKNESS U-STANGENDICKE	4mm-6mm	
MANDAL KALINLIĞI LATCH THICKNESS	1x50m-1x20m	
MANDAL MALZEMESİ LATCH MATERIAL VERRIEGELUNGSMATERIAL	Sertleştirilmiş çelik Hardened steel Geharteter stahl	
KAPLAMA COATING ÜBERZUG	Çinko Zinc Zink	

Değerler milimetre olarak verilmiştir.

Values are given in millimeters.

Werte sind in millimetern angegeben.

KAPI HİDROLİKLERİ

DOOR CLOSERS

TÜRSCHLIESSERE

ÇEŞİTLERİ TYPES TYPEN	(NO-3) 40-65 KG	(NO-4) 60-85 KG
AĞIRLIK (gram) WEIGHT (grams) GEWICHT (gramm)	2200	2500
MALZEME MATERIAL MATERIAL	Alüminyum gövde + çelik aksesuar Aluminum body + stell accessories Aluminiumgehäuse + stahlzubehör	
YÜZEY AUFTAUCHEN SURFACE	Mat satin Matt satin Matt satin	Mat satin Matt satin Matt satin
DETAY DETAIL DETAIL	3 yıl garantilidir. Guaranteed for 3 years. 3 Jahre garantie.	
	Sağ ve sol kullanıma uygundur. Suitable for right and left use. Geeignet für den rechten und den linken gebrauch.	
	Kapanmaz hızı ayarlanabilir. Close speed can be adjusted. Schliebgeschwindigkeit kann eingestellt werden.	
KULLANIM AMACI PURPOSE OF USAGE NUTZUNGSZWECK	Bu ürünün ana görevi kapıyı kapatmaktır ancak kapanma pozisyonu yaklaştığında kapıyı yavaşlatmak ve kapının yumuşak kapanmasını sağlamak için de kullanılır. The main duty of this product is to close the door, but it is also used to slow the door to slow up and provide soft closing of the door when it close the closing position. Die hauptaufgabe dieses produkts ist das schliessen der tür, aber es wird auch verwendet, um die tür zu verlangsamen und ien sanftes schliessen der tür zu gewährleisten wenn sie sich der geschlossenen position nahe.	

TEKNİK ÇİZİM

TECHNICAL DRAWING

TECHNISCHE ZEICHNUNG

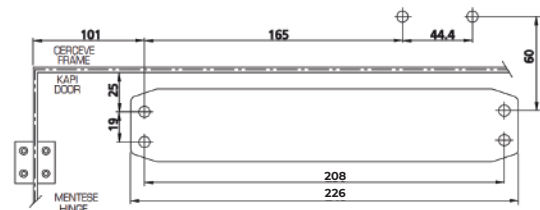

40-65 kg

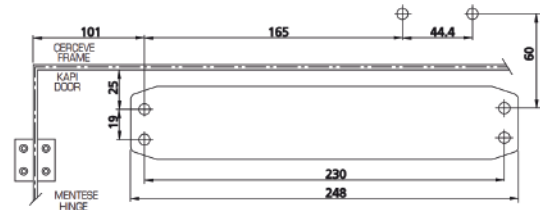

60-85 kg / 80-120 kg

Değerler milimetre olarak verilmiştir.

Values are given in millimeters.

Werte sind in millimetern angegeben.

ÇEŞİTLERİ TYPES TYPEN	STANDART SERİ STANDARD SERIES STANDARDSERIE	FİNLİ SERİ FIN SERIES
ÖLÇÜLERİ DIMENSIONS MASSE	Kullanım alanlarına göre farklı ölçü ve yoğunlukta ürün mevcuttur. Products are available in different sizes and density according to the areas of usage. produkte sind in unterschiedlichen grössen und dichten entsprechend den anwendungsbereichen erhältlich.	
HAMMADDE RAW MATERIALS ROHES MATERIAL	Polipropilen	Polipropilen
DETAY DETAIL DETAIL	Silikonlu Silicone Silikon	Silikonludur. Ortasındaki finli şerit sayesinde sızdırmazlık özelliğini artırır. It is silicone. Increases its leaking properties thanks to the finished strip in the middle. Es ist silikon. Erhöht seine auslaufeigenschaften durch den fertigen streifen in der mitte.
	Kil fitil pvc, alüminyum veya ahşaptan yapılan kapı ve pencerelerde su, toz ve ses gibi istenmeyen faktörleri dışarıda tutan bir malzemedir. The material that keeps undesired factors such as water, dust and sound on doors and windows made of pvc, aluminum or wood. Dieses material ist ein material, das unerwünschte faktoren wie wasser, staub und schall auf türen und fenster aus pvc, aluminium oder holz hält.	

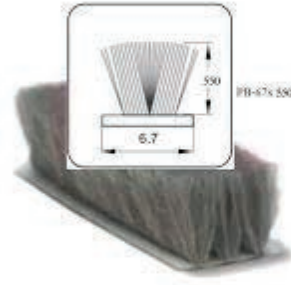

KİLİTLİ PENCERE KOLLARI

LOCKED WINDOW HANDLES

VERSCHLOSSENER FENSTERGRIFFE

ÇEŞİTLERİ TYPES TYPEN	TEKLİ KOLLAR SINGLE ARM EINZELARM	ÇİFTLİ KOLLAR DOUBLE ARM DOPPELARM		
AĞIRLIK (gram) WEIGHT (grams) GEWICHT (gramm)	205	375		
MALZEME MATERIAL MATERIAL	Taban zamak, kol ve kaplama alüminyum Base zamak, handle and coating aluminum Untergestell zamak, griff und beschichtung aluminium	Alüminyum Aluminium Alles Aluminium		
RENK COLOUR FARBE	Beyaz White Weiss	Siyah Black Schwarz	Gümüş gri Silver grey Silber grau	Antrasit Anthracite Anthrazitgrau
	RAL9016	RAL 9005	RAL 7001	RAL 7016

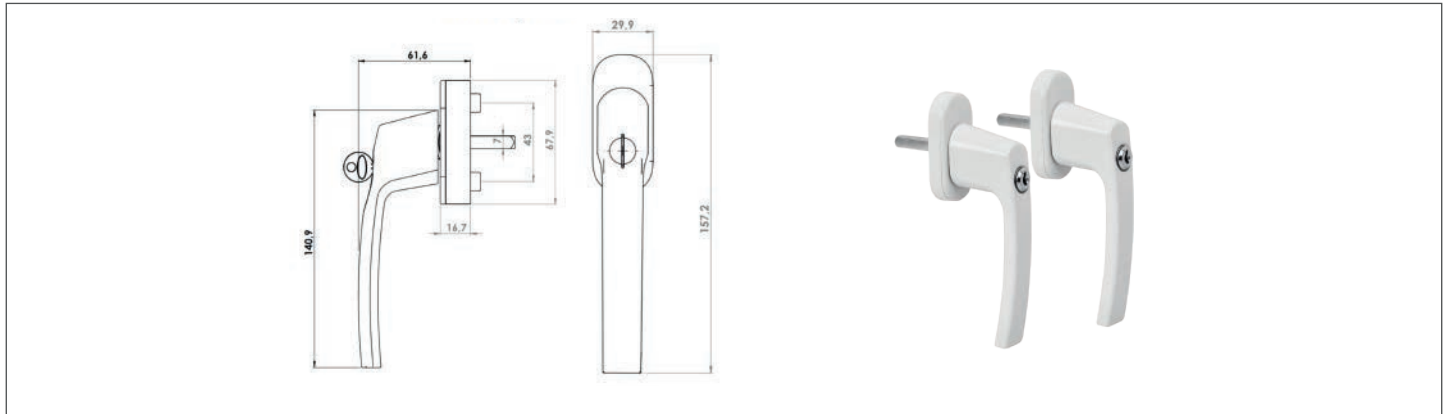

PENCERE SÜRGÜ TEKERİ

WINDOW SLIDER

FENSTERSCHIEBER

	UZUNLUK (mm) LENGTH (mm) LÄNGE (mm)	GENİŞLİK (mm) WIDTH (mm) BREITE (mm)	YÜKSEKLİK (mm) HEIGHT (mm) HÖHE (mm)	NET AĞIRLIK(gr) NET WEIGHT (gr) NETTOGEWICHT (gr)	TAŞIMA KAPASİTESİ (kg) CARRYING CAPACITY (kg) TRAGKAPAZİTÄT (kg)	KOLİ İÇİ ADET QUANTITY PER CARTON MENGE PRO KARTON
TEKER DETAYI WHEEL DETAIL RADDETAIL	<p>Polyamid teker, kırılmaya karşı dirençlidir. Çalıştığı zemine zarar vermez ve renk atması olmaz.</p> <p>Polyamide wheel is resistant to breakage. It does not damage the surface it works on and does not cause discoloration.</p> <p>Das Polyamidrad ist bruchsicher. Es beschädigt die Oberfläche, auf der es arbeitet, nicht und verursacht keine Verfärbungen.</p>					
KULLANIM AMACI PURPOSE OF USAGE ZWECK DER NUTZUNG	<p>Pencere sürgü tekeri; sürgülü kapı ve pencere sistemlerinizi daha işlevsel ve dayanıklı hale getirir. Bu tekerlekler, sessiz ve pürüzsüz bir hareket sağlayarak yaşam alanlarınızda konforu artırır. Dayanıklı malzemesi sayesinde uzun ömürlü bir kullanım sunar.</p> <p>Window slider; it makes your sliding door and window systems more functional and durable. These wheels increase comfort in your living spaces by providing quiet and smooth movement. Thanks to its durable material, it offers long-lasting use.</p> <p>Fensterschieber; Es macht Ihre Schiebetür- und Fenstersysteme funktionaler und langlebiger. Diese Räder erhöhen den Komfort in Ihren Wohnräumen, indem sie für eine leise und reibungslose Bewegung sorgen. Dank seines langlebigen Materials bietet es eine lange Nutzungsdauer.</p>					

Değerler milimetre olarak verilmiştir.

Values are given in millimeters.

Werte sind in millimetern angegeben.

SIVA FİLELERİ

FIBERGLASS MESH

GLASFASERNETZ

ÖLÇÜLERİ DIMENSIONS MASSE	160 g	160 g	75 g
AĞIRLIK (gram/m ²) WEIGHT (grams/m ²) GEWICHT (gramm/m ²)	160	160	75
UZUNLUK (m/top) LENGTH (m/roll) LÄNGE (m/rollen)	50	50	50
RENK COLOUR FARBE	Turuncu Orange	Mavi Blue Blau	Beyaz White Weiss
MALZEME MATERIAL	Hammaddesi cam elyafı olup, b+ kalitedir. Its raw material is glass fiber and is b+ quality. Sein rohstoff ist glasfaser und ist b+ qualität.		
DETAY DETAIL	Ürünlerin eni 1 metre boyu 50 metredir. The width of the products is 1 meters and 50 meters in length. Die breite der produkte beträgt 1 meter und 50 meter in der länge. 1 Top = 50 M ² . 1x1 Ölçüsünde 4*4 Kare Bulunur. (1 Inch 25,4 Mm). 1 Roll = 50 M ² . There Are 4*4 Square in 1x1 Size. 1 Rollen = 50 M ² . Es Gibt 4*4 Quadratische in 1 X 1 Grösse.		
KULLANIM AMACI PURPOSE OF USAGE NUTZUNGSZWECK	Binalarda mantolamada ve ses yalıtımı için kullanılır. It is used for heating and sound insulation in buildings. Es wird zur heizung und schalldämmung in gebäuden verwendet.		

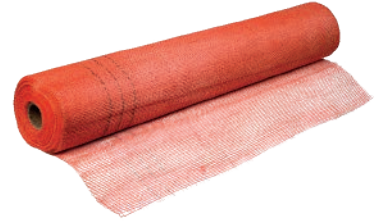

DÜZ SİNEK TELLERİ

FIBERGLASS INSET SCREENS

FIBERGLAS INSET SCREEN

ÖLÇÜLERİ DIMENSIONS MASSE	60 cm	80 cm	100 cm	120 cm	140 cm	160 cm	180 cm
AĞIRLIK (gram/m ²) WEIGHT (grams/m ²) GEWICHT (gramm/m ²)	105	105	105	105	105	105	105
UZUNLUK (m/top) LENGTH (m/roll) LÄNGE (m/rollen)	30	30	30	30	30	30	30
MALZEME MATERIAL	%35 yüksek kaliteli fiberglas ipliği + %65 plastiktir. 35% high quality fiberglass yarn + 65% plastic. 35 % hochwertiges glasfasergarn + 65 % kunststoff.						
KARE SAYISI NUMBER OF SQUARE ANZAHL DES QUADRATS	1x1 ölçüsünde 16*18 kare bulunur. (1 inch 25,4 mm) There is 16*18 square in 1x1 measurement. (1 inch 25.4 mm) Es gibt 16 * 18 quadratische in 1 x 1 messung. (1 zoll 25,4 mm)						



Değerler milimetre olarak verilmiştir.

Values are given in millimeters.

Werte sind in millimetern angegeben.



İŞ
GÜVENLİĞİ
OCCUPATIONAL
SAFETY

İŞ ELDİVENLERİ

WORK GLOVES

ARBEITSHANDSCHUHE





ÇEŞİTLERİ TYPES TYPEN	STD350	STD1	STD2	STD2 FLEX	STD2 FLEX+	STD PRO
ÜRÜN GÖRSELİ PRODUCT IMAGE PRODUKT BILD						
DAYANIM SINIFI RESISTANCE CLASS WIDERSTANDSKLASSE	2111X	2121X	3121X	3121X	3121X	4121X
DOKUMA WOVEN TYPE GEWEBTER TYP	Pamuk Cotton Baumwolle	Pamuk Cotton Baumwolle	Pamuk Cotton Baumwolle	Pamuk Cotton Baumwolle	Pamuk Cotton Baumwolle	Pamuk Cotton Baumwolle
KAPLAMA COATING GLASUR	3/4 Nitril 3/4 Nitrile 3/4 Nitril	3/4 Nitril 3/4 Nitrile 3/4 Nitril	3/4 Nitril 3/4 Nitrile 3/4 Nitril	3/4 Nitril 3/4 Nitrile 3/4 Nitril	Nitril Nitrile Nitril	3/4 Nitril 3/4 Nitrile 3/4 Nitril
RENK COLOUR FARBE	Sarı Yellow Gelb	Sarı Yellow Gelb	Sarı Yellow Gelb	Sarı Yellow Gelb	Sarı Yellow Gelb	Sarı Yellow Gelb
BEDEN SIZES GRÖSSEN	9-10	9-10	9-10	9-10	9-10	9-10

ÇEŞİTLERİ TYPES TYPEN	STDP3	STDP5	STDP7	STDP10	STDP15	STDP ZEBRA	STDP PL9
ÜRÜN GÖRSELİ PRODUCT IMAGE PRODUKT BILD							
DAYANIM SINIFI RESISTANCE CLASS WIDERSTANDSKLASSE	2121X	3121X	3131X	3121X	3121X	3131X	4131X
DOKUMA WOVEN TYPE GEWEBTER TYP	Polyester	Polyester	Polyester	Polyester	Polyester	Polyester	Polyester
KAPLAMA COATING GLASUR	Nitril Nitrile Nitril	Nitril Nitrile Nitril	Nitril Nitrile Nitril	Pu	Pu	Nitril Nitrile Nitril	Nitril Nitrile Nitril
RENK COLOUR FARBE	Sarı - Gri Yellow - Grey Gelb - Grau	Sarı Yellow Gelb	Sarı Yellow Gelb	Siyah Black Schwarz	Siyah Black Schwarz	Siyah - Kırmızı Black - Red Schwarz - Rot	Siyah - Kırmızı Black - Red Schwarz - Rot
BEDEN SIZES GRÖSSEN	9-10	9-10	9-10	7-8-9-10	7-8-9-10	9-10	9-10

Değerler milimetre olarak verilmiştir.

Values are given in millimeters.

Werte sind in millimetern angegeben.

ÇEŞİTLERİ TYPES TYPEN	KLASİK	CROSS 603	CROSS 602
ÜRÜN GÖRSELİ PRODUCT IMAGE PRODUKTBILD			
AĞIRLIK (gram) WEIGHT (grams) GEWICHT (gramm)	28,00	23,20	23,70
RENK COLOUR FARBE			
SERTİFİKASYON CERTIFICATION ZERTIFIZIERUNG	Tse en 166 kapsamında ve ce belgelidir. It is within the scope of tse en 166 and ce certified. Es liegt in den geltungsbereich tse en 166 und ce-zertifiziert.		
KULLANIM AMACI Gözleri zararlı ve zehirli maddelerden ve bunların doğuracağı tehlikelerden koruyacak şekilde dizayn edilmiştir. Gözlük genellikle; • Küçük parçalar ve tozlardan, • Talaş ve fırlayan büyük parçalar veya kıvılcımlardan, • Ultraviyole(UV) ve kızılötesi (IR) (ısı ışını) dahil sağlığa zararlı ışınlardan ve göz almadan, • Yüksek ısılı püskürtme maddelerinden, • Kimyasal sıçramalar, erimiş metallere, • Zehirli gazlardan, gözleri korumak için kullanılır.	PURPOSE OF USAGE It is designed to protect the eyes from harmful and toxic substances and the dangers they may pose. Glasses are usually; • Small parts and dust, • Sawdust and large flying pieces or sparks, • From harmful rays to health, including ultraviolet (UV) and infrared (IR) (heat rays) and without eye protection, • From high-temperature spraying agents, • Chemical splashes, molten metals, • It is used to protect eyes from toxic gases.	NUTZUNGSZWECK Es soll die Augen vor schädlichen und giftigen Stoffen und den Gefahren, die sie darstellen können, schützen. Gläser sind normalerweise; • Kleinteile und Staub, • Sägemehl und große herumfliegende Teile oder Funken, • Vor gesundheitsschädlichen Strahlen, einschließlich Ultraviolett (UV) und Infrarot (IR) (Wärmestrahlen) und ohne Augenschutz, • von Hochtemperatur-Spritzmitteln, • Chemikalienspritzer, geschmolzene Metalle, • Es wird verwendet, um die Augen vor giftigen Gasen zu schützen.	

SÜET S01 İŞ AYAKKABISI

SAFETY SHOES

SICHERHEITSSCHUHE



Ürün Özellikleri

Poliüretan tek ve çift dansiteli (katmanlı) taban seçeneği.
Yumuşak İç Taban
Hava Geçirgen Astar
Süet
Çelik Burunlu

Product Properties

Polyurethane single and double density (layered) sole choice.
Soft Insole
Air Permeable Primer
Suede
Steel Toe

Produkt Eigenschaften

Sohlenauswahl aus Polyurethan mit einfacher und doppelter Dichte (geschichtet).
Weiche Innensohle
Luftdurchlässige Grundierung
Deri
Wildleder

RENK/ COLOUR/ FARBE	BEDEN/ SIZE/ SCHUHGRÖSSE	STANDARD
SİYAH/ BLACK/ SCHWARZ	EUR 36	CE EN 20343
SİYAH/ BLACK/ SCHWARZ	EUR 37	CE EN 20344
SİYAH/ BLACK/ SCHWARZ	EUR 38	CE EN 20345
SİYAH/ BLACK/ SCHWARZ	EUR 39	CE EN 20345
SİYAH/ BLACK/ SCHWARZ	EUR 40	CE EN 20345
SİYAH/ BLACK/ SCHWARZ	EUR 41	CE EN 20345
SİYAH/ BLACK/ SCHWARZ	EUR 42	CE EN 20345
SİYAH/ BLACK/ SCHWARZ	EUR 43	CE EN 20345
SİYAH/ BLACK/ SCHWARZ	EUR 44	CE EN 20345
SİYAH/ BLACK/ SCHWARZ	EUR 45	CE EN 20345
SİYAH/ BLACK/ SCHWARZ	EUR 46	CE EN 20345

DERİ S02 İŞ AYAKKABISI

SAFETY BOATS

SICHERHEITSBOOTE



Ürün Özellikleri

Poliüretan tek ve çift dansiteli (katmanlı) taban seçeneği.
Yumuşak İç Taban
Hava Geçirgen Astar
Deri
Çelik Burunlu

Product Properties

Polyurethane single and double density (layered) sole choice.
Soft Insole
Air Permeable Primer
Deri
Steel Toe

Produkt Eigenschaften

Sohlenauswahl aus Polyurethan mit einfacher und doppelter Dichte (geschichtet).
Weiche Innensohle
Luftdurchlässige Grundierung
Deri
Stahlkappe

RENK/ COLOUR/ FARBE	BEDEN/ SIZE/ SCHUHGRÖSSE	STANDARD
SİYAH/ BLACK/ SCHWARZ	EUR 36	CE EN 20343
SİYAH/ BLACK/ SCHWARZ	EUR 37	CE EN 20344
SİYAH/ BLACK/ SCHWARZ	EUR 38	CE EN 20345
SİYAH/ BLACK/ SCHWARZ	EUR 39	CE EN 20345
SİYAH/ BLACK/ SCHWARZ	EUR 40	CE EN 20345
SİYAH/ BLACK/ SCHWARZ	EUR 41	CE EN 20345
SİYAH/ BLACK/ SCHWARZ	EUR 42	CE EN 20345
SİYAH/ BLACK/ SCHWARZ	EUR 43	CE EN 20345
SİYAH/ BLACK/ SCHWARZ	EUR 44	CE EN 20345
SİYAH/ BLACK/ SCHWARZ	EUR 45	CE EN 20345
SİYAH/ BLACK/ SCHWARZ	EUR 46	CE EN 20345

Değerler milimetre olarak verilmiştir.

Values are given in millimeters.

Werte sind in millimetern angegeben.

DERİ S02 KAYNAKÇI İŞ AYAKKABISI

SAFETY SHOES

SICHERHEITSSCHUHE



Ürün Özellikleri

Poliüretan tek ve çift dansiteli (katmanlı) taban seçeneği.
Yumuşak İç Taban
Hava Geçirgen Astar
Deri
Çelik Burunlu

Product Properties

Polyurethane single and double density (layered) sole choice.
Soft Insole
Air Permeable Primer
Deri
Steel Toe

Produkt Eigenschaften

Sohlenauswahl aus Polyurethan mit einfacher und doppelter Dichte (geschichtet).
Weiche Innensohle
Luftdurchlässige Grundierung
Deri
Stahlkappe

RENK/ COLOUR/ FARBE	BEDEN/ SIZE/ SCHUHGRÖSSE	STANDARD
SİYAH/ BLACK/ SCHWARZ	EUR 40	CE EN 20345
SİYAH/ BLACK/ SCHWARZ	EUR 41	CE EN 20345
SİYAH/ BLACK/ SCHWARZ	EUR 42	CE EN 20345
SİYAH/ BLACK/ SCHWARZ	EUR 43	CE EN 20345
SİYAH/ BLACK/ SCHWARZ	EUR 44	CE EN 20345
SİYAH/ BLACK/ SCHWARZ	EUR 45	CE EN 20345
SİYAH/ BLACK/ SCHWARZ	EUR 46	CE EN 20345

YAĞMURLUK

RAINCOAT

REGENJACKE

KALINLIK (mc) THICKNESS (mc) DICKE (mc)	25	32	
RENK COLOUR FARBE	Sarı, Yeşil ve Mavi Yellow, Green and Blue Gelb, Grün und Blau	Sarı, Yeşil ve Mavi Yellow, Green and Blue Gelb, Grün und Blau	
ASTAR TECHNICAL DETAILS TECHNISCHE DETAILS	Astarsız Unlayered Ungeschichtet	Polyester Polyester Polyester	
MALZEME MATERIAL	PVC	PVC	
TEKNİK ÖZELLİKLER TECHNICAL DETAILS TECHNISCHE DETAILS	Suya dayanıklı yapı, kapüşon, çit çit ve fermuar seçeneği, 2 ön cep Waterproof construction, hoodie, snap and zipper choice, 2 front pockets Wasserdichte konstruktion, hoodie, druckknopf- und reißverschlussauswahl, 2 vordertaschen		

Değerler milimetre olarak verilmiştir.

Values are given in millimeters.

Werte sind in millimetern angegeben.

KELEPÇELER VE KİLİTLER

CLAMPS AND
LOCKS



STD ASMA KİLİTLER

STD PADLOCKS

STD VORHÄNGESCHLÖSSER

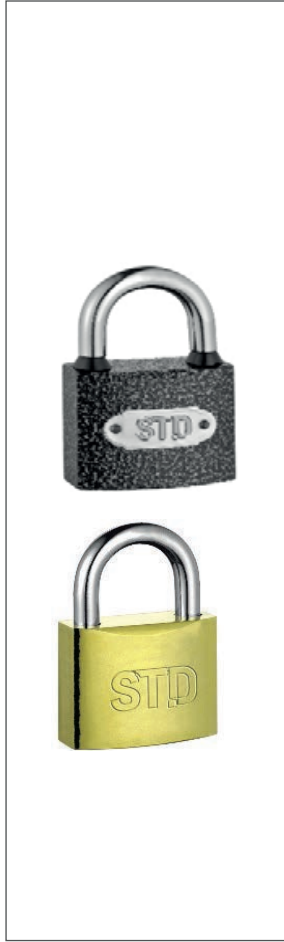

ÖLÇÜLERİ DIMENSIONS MASSE	20mm	25mm	32mm	38mm	50mm	63mm
AĞIRLIK WEIGHT GEWICHT	32	50	93	144	310	540
GÖVDE MALZEMESİ BODY MATERIAL KÖRPERMATERIAL	Malzeme çelik, sarılar piriç; griler siyah kaplama Material steel, yellows brass; gray black plating Material Stahl, gelbes messing; grauer schwarzer überzug					
KANCA MALZEMESİ HOOK MATERIAL HAKENMATERIAL	Malzeme çelik, kaplama krom Material steel, plated chrome Material stahl, verchromt					
İÇ SİLİNDİR MALZEMESİ INSIDE CYLINDER MATERIAL INNERES ZYLINDERMATERIAL	Tamami piriç silindir All brass cylinder Alle messingzylinder					
ANAHTAR MALZEMESİ KEY MATERIAL SCHLÜSSELMATERIAL	Malzeme çelik, kaplama nikel Material steel, plated nickel Material stahl, nickel beschichtet					
SIZDIRMAZLIK LASTİĞİ SEALING RUBBER DICHTUNGSGUMMI	20 ve 25mm hariç hepsinde bulunur. Verfügbar für alle ausser 20 und 25 mm. Available on all except 20 and 25mm.					

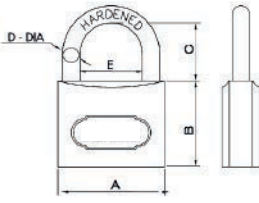
TEKNİK ÖLÇÜLERİ TECHNISCHE ABMESSUNGEN TECHNICAL DIMENSIONS	20mm	25mm	32mm	38mm	50mm	63mm	
	A	21	25	32	38	50	63
	B	19,5	24,5	30	35	43	50
	C	11	12,5	15	17	23	26,5
	D	3,2	4,3	5,3	6,2	8,8	10,5
	E	10,5	12	16	19,5	27	32
	F	11,5	15	19	19,5	27	35

Değerler milimetre olarak verilmiştir.

Values are given in millimeters.

Werte sind in millimetern angegeben.

STDeppo ASMA KİLİTLER

STDeppo PADLOCKS

STDeppo VORHÄNGESCHLÖSSER

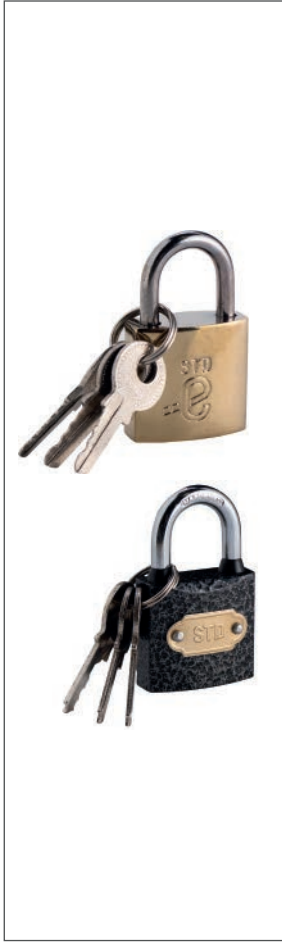

ÖLÇÜLERİ DIMENSIONS MASSE	25mm	32mm	38mm	50mm	63mm
AĞIRLIK WEIGHT GEWICHT	34	63	100	215	360
GÖVDE MALZEMESİ BODY MATERIAL KÖRPERMATERIAL	Malzeme demir, sarı ve siyah kaplama. Material iron, yellow and black plating. Material eisen, gelb und schwarz beschichtet.				
KANCA MALZEMESİ HOOK MATERIAL HAKENMATERIAL	Malzeme demir, kaplama krom. Material iron, plated chrome. Material eisen, verchromt.				
İÇ SİLİNDİR MALZEMESİ INSIDE CYLINDER MATERIAL INNERES ZYLINDERMATERIAL	Silindir demir, uç kısmı piriç. Cylinder iron, end part brass. Zylindereisen, endteil messing.				
ANAHTAR MALZEMESİ KEY MATERIAL SCHLÜSSELMATERIAL	Malzeme demir, kaplama krom. Material iron, plated chrome. Material eisen, verchromt.				
SIZDIRMAZLIK LASTİĞİ SEALING RUBBER DICHTUNGSGUMMI	Hiçbir ölçüde bulunmaz. Not available to any size. Nicht in jeder grösse verfügbar.				

TEKNİK ÖLÇÜLERİ TECHNISCHE ABMESSUNGEN TECHNICAL DIMENSIONS	25mm	32mm	38mm	50mm	63mm
	A 25	32	37	48	61
	B 24	28	32	40	49
	C 12	13	13	18	20
	D 14	17	21	26	32
	E 4	4,5	5,5	7	8,5
	F 13	16	20	25	31

Değerler milimetre olarak verilmiştir.

Values are given in millimeters.

Werte sind in millimetern angegeben.

STD UZUN KANCALI ASMA KİLİTLER

STD LONG HOOK PADLOCKS

STD LANGE HAKENSCHLÖSSER



ÖLÇÜLERİ DIMENSIONS MASSE	32mm	38mm	50mm	63mm
AĞIRLIK WEIGHT GEWICHT	100	168	320	540
GÖVDE MALZEMESİ BODY MATERIAL KÖRPERMATERIAL	Malzeme çelik, sarılar piring; griler siyah kaplama. Material steel, yellows brass; gray black plating. Material stahl, gelbes messing; grauer schwarzer überzug.			
KANCA MALZEMESİ HOOK MATERIAL HAKENMATERIAL	Malzeme çelik, kaplama krom. Material steel, plated chrome. Material stahl, verchromt.			
İÇ SİLİNDİR MALZEMESİ INSIDE CYLINDER MATERIAL INNERES ZYLINDERMATERIAL	Silindir çelik, uç kısmı piring. Cylinder steel, end brass. Zylinder stahl, ende messing.			
ANAHTAR MALZEMESİ KEY MATERIAL SCHLÜSSELMATERIAL	Malzeme çelik, kaplama nikel. Material steel, plated nickel. Material stahl, nickel beschichtet.			
SIZDIRMAZLIK LASTİĞİ SEALING RUBBER DICHTUNGSGUMMI	Hepsinde bulunur. Has everything. Hat alles.			

TEKNİK ÖLÇÜLERİ TECHNISCHE ABMESSUNGEN TECHNICAL DIMENSIONS	32mm	38mm	50mm	63mm	
	A	32	38	50	63
	B	30	35	42	52
	C	15	17	21,5	25
	D	5,1	6,1	8	9,8
	E	16	19,5	27	32
	F	48	60	64	65

Değerler milimetre olarak verilmiştir.

Values are given in millimeters.

Werte sind in millimetern angegeben.

STD KAYAR MİLLİ ASMA KİLİTLER

STD SLIDING SHAFT PADLOCKS

STD SCHIEBEWELLEN-VORSCHLÖSSER



ÖLÇÜLERİ DIMENSIONS MASSE	70mm	80mm	90mm
AĞIRLIK WEIGHT GEWICHT	427	481	534
GÖVDE MALZEMESİ BODY MATERIAL KÖRPERMATERIAL	Malzeme çelik, sarılar pirinç; griler nikel kaplama. Material stahl, gelbes messing; graue vernickelung. Material steel, yellows brass; gray nickel plating.		
KANCA MALZEMESİ HOOK MATERIAL HAKENMATERIAL	Malzeme çelik, kaplama krom. Material steel, plated chrome. Material stahl, verchromt.		
İÇ SİLİNDİR MALZEMESİ INSIDE CYLINDER MATERIAL INNERES ZYLINDERMATERIAL	Tamamı pirinç silindir. All brass cylinder. Alle messingzylinder.		
ANAHTAR MALZEMESİ KEY MATERIAL SCHLÜSSELMATERIAL	Malzeme çelik, kaplama nikel. Material steel, plated nickel. Material stahl, nickel beschichtet.		

TEKNİK ÖLÇÜLERİ TECHNISCHE ABMESSUNGEN TECHNICAL DIMENSIONS	70mm	80mm	90mm	
	A	70	80	90
	B	55	55	55
	C	20	20	20
	D	11	11	11
	E	24	30	30
	F	32	32	32

Değerler milimetre olarak verilmiştir.

Values are given in millimeters.

Werte sind in millimetern angegeben.

STD ŞİFRELİ KİLİTLER

STD ENCRYPTED LOCKS

VERSCHLÜSSELTE STD-SPERREN



ÖLÇÜLERİ DIMENSIONS MASSE	20mm	28mm	38mm
AĞIRLIK WEIGHT GEWICHT	50	117	202
GÖVDE MALZEMESİ BODY MATERIAL KÖRPERMATERIAL	Prinç gövde Brass body Messingkörper	Prinç gövde Brass body Messingkörper	Prinç gövde Brass body Messingkörper
KANCA MALZEMESİ HOOK MATERIAL HAKENMATERIAL	Çelik kanca Steel hook Stahlhaken	Çelik kanca Steel hook Stahlhaken	Çelik kanca Steel hook Stahlhaken
BASAMAK SAYISI NUMBER OF STEPS ANZAHL DER SCHRITTE	3 kombinasyonlu 3 combinations 3 kombinationen	3 kombinasyonlu 3 combinations 3 kombinationen	4 kombinasyonlu 4 combinations 4 kombinationen

TEKNİK ÖLÇÜLERİ TECHNISCHE ABMESSUNGEN TECHNICAL DIMENSIONS	20mm	28mm	38mm
	21	30	40
	30	31	39,5
	10	11	12
	3	4	5

BARELLER

CYLINDERS

ZYLINDERE

ÖLÇÜLERİ DIMENSIONS MASSE	63mm	83mm	90mm	100mm
AĞIRLIK (gram) WEIGHT (grams) GEWICHT (gramm)	172	190	220	250
MALZEME MATERIAL MATERIAL	Zamak			

TEKNİK ÇİZİM

TECHNICAL DRAWING

TECHNISCHE ZEICHNUNG



A	26	26	26	30	26	30	33	30	35	33	35	35	40	40	45
B	26	30	32	30	35	35	33	40	35	40	40	45	40	45	45
L	62	66	68	70	71	75	76	80	80	83	85	90	90	95	100

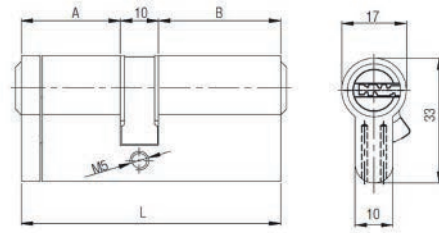

KELEPÇELER

CLAMPS

KLEMMEN

ÖLÇÜLERİ DIMENSIONS MASSE	BANT GENİŞLİĞİ BAND WIDTH BANDBREITE	ÜRÜN TİPİ PRODUCT TYPE PRODUKTART	HAM MADDE RAW MATERIALS ROHES MATERIAL	ÜRÜN GÖRSELİ PRODUCT IMAGE PRODUKTBILD
8*13	8mm	A	DKP	
10*16	8mm	A	DKP	
13*19	8mm	A	DKP	
16*23	8mm	A	DKP	
18*25	8mm	A	DKP	
19*26	13mm	B	DKP	
20*30	13mm	B	DKP	
22*36	13mm	B	DKP	
25*42	13mm	B	DKP	
28*48	13mm	B	DKP	
32*51	13mm	B	DKP	
38*58	13mm	B	DKP	
44*64	13mm	B	DKP	
51*72	13mm	B	DKP	
57*76	13mm	B	DKP	
65*82	13mm	B	DKP	
76*92	13mm	B	DKP	
85*103	13mm	B	DKP	
92*110	13mm	B	DKP	
105*121	13mm	B	DKP	
115*135	13mm	B	DKP	
130*146	13mm	B	DKP	
146*164	13mm	B	DKP	

Değerler milimetre olarak verilmiştir.

Values are given in millimeters.

Werte sind in millimetern angegeben.



MAKİNELER
MACHINERY

STANLEY JENERATÖR

GENERATOR

GENERATOR



Model Adı	SG3100B
Ses Seviyesi (dB)	96dB(A)
Frekans	50 Hz
Motor Gücü	7Hp
Motor Tipi	Tek Silindir, 4 Zamanlı, Hava Soğutmalı
Genişlik	44,5 cm
Uzunluk (cm)	65 cm
Yükseklik	44,5 cm
Net Ağırlık	40 kg
Maksimum Çıkış Gücü	2,9 kW
Sürekli Çıkış Gücü	2,6 kW
Yakıt Tipi	Kurşunsuz Benzin
Yakıt Kapasitesi	15 L
Yakıt Tüketimi	1253 g/h
Yağ Kapasitesi	0,6 L
Çalıştırma Şekli	İpli

Model Name	SG3100B
Generator type	Synchronous
Protection type	IP 23M
Continuous rated power Prated (SI)	2.6 kW
Maximum power Pmax	2.9 kW
Rated voltage U _{rated}	2 x 230 V~
Rated current I _{rated}	11.3 A
Frequency Frated	50 Hz
Drive engine design	Single-cylinder forced air-cooled 4-stroke OHV
Displacement	212 cm ³
Fuel type	Normal unleaded petrol
Tank capacity	15 L
Engine oil	Appox.0.6 l (15W40/<0 oC: 5W30)
Consumption at 2/3 load	1253 g/h
Weight	40 kg
Guaranteed sound power level LWA	96 dB(A)
Power class:	G1
Max. Temperature	40 °C
Max. altitude (above mean sea level)	1000 m
Spark plug	LDF7RTC
Box dimensions (LxWxH)	65,00 x 44,50 x 44,5 cm

Değerler milimetre olarak verilmiştir.

Values are given in millimeters.

Werte sind in millimetern angegeben.

STANLEY JENERATÖR

GENERATOR

GENERATOR



Model Adı	SG5600B
Ses Seviyesi (dB)	97dB(A)
Frekans	50 Hz
Motor Gücü	18Hp
Motor Tipi	Tek Silindir, 4 Zamanlı, Hava Soğutmalı
Genişlik	53 cm
Uzunluk (cm)	74 cm
Yükseklik	55 cm
Net Ağırlık	82,5 kg
Maksimum Çıkış Gücü	3,3 kW (230V~/)5,5 kW (400V~)
Sürekli Çıkış Gücü	3 kW (230V~/)5 kW (400V~)
Yakıt Tipi	Kurşunsuz Benzin
Yakıt Kapasitesi	25 L
Yakıt Tüketimi	2964 g/h
Yağ Kapasitesi	1.1 L
Çalıştırma Şekli	Elektrik Marşlı

Model Name	SG5600B
Generator type	Synchronous
Protection type	IP 23M
Continuous rated power Prated (SI)	3 kW (230V~/)5 kW (400V~)
Maximum power Pmax	3.3 kW (230V~/)5.5 kW (400V~)
Rated voltage Urated	2 x 230 V~ 1 x 400V 3~
Frequency Frated	50 Hz
Drive engine design	Single-cylinder forced air-cooled 4-stroke OHV
Displacement	458 cm ³
Fuel type	Normal unleaded petrol
Tank capacity	25 L
Engine oil	Appox.1.1 L (15W40/<0 oC: 5W30)
Net weight	82.5 kg
Guaranteed sound power level LWA	97 dB(A)
Power class	G1
Max. Temperature	40 °C
Spark plug	LD F7RTC
Box dimensions (LxWxH)	74,00 x 53,00 x 55 cm

Değerler milimetre olarak verilmiştir.

Values are given in millimeters.

Werte sind in millimetern angegeben.

STANLEY JENERATÖR

GENERATOR

GENERATOR



Model Adı	SG7500B
Ses Seviyesi (dB)	97dB(A)
Frekans	50 Hz
Motor Gücü	18Hp
Motor Tipi	Tek Silindir, 4 Zamanlı, Hava Soğutmalı
Genişlik	53 cm
Uzunluk (cm)	74 cm
Yükseklik	55 cm
Net Ağırlık	88 kg
Maksimum Çıkış Gücü	3,3 kW (230 V~)/ 7,5 kW (400 V 3~)
Sürekli Çıkış Gücü	3,0 kW (230 V~)/ 7,0 kW (400 V 3~)
Yakıt Tipi	Kurşunsuz Benzin
Yakıt Kapasitesi	25 L
Yakıt Tüketimi	3432g/h
Yağ Kapasitesi	1.1 L
Çalıştırma Şekli	Elektrik Marşlı

Model Name	SG7500B
Generator type:	Synchronous
Protection type:	IP 23M
Continuous rated power Prated (S1):	3.0 kW (230 V~)/ 7.0 kW (400 V 3~)
Maximum power Pmax:	3.3 kW (230 V~)/ 7.5 kW (400 V 3~)
Rated voltage Urated:	2 x 230 V~ 1 x 400V 3~
Frequency Frated:	50 Hz
Drive engine design:	Single-cylinder forced air-cooled 4-stroke OHV
Displacement:	458 cm ³
Fuel type: N	Normal unleaded petrol
Tank capacity:	25 L
Engine oil:	Appox.1.1 l (15W40/<0 oC: 5W30)
Gross weight:	96.5 Kg
Net weight:	88 Kg
Guaranteed sound power level LWA:	97 dB(A)
Power class:	G1
Max. temperature:	40 °C
Spark plug:	LD F7RTC
Box dimensions (LxWxH):	74,00 x 53,00 x 55 cm

Değerler milimetre olarak verilmiştir.

Values are given in millimeters.

Werte sind in millimetern angegeben.

MANYETİK KALIP AYIRICI

MAGNETIC VISE

MAGNETISCHER SCHRAUBSTOCK

MODEL MODEL MODELL	UZUNLUK LENGTH LÄNGE	GENİŞLİK (mm) WIDTH (mm) BREITE (mm)	YÜKSEKLİK (mm) HEIGHT (mm) HÖHE (mm)	ET AĞIRLI (kg) NET WEIGHT (kg) NETTOGEWICHT (kg)	SIKIŞTIRMA KUVVETİ COMPRESSION FORCE KOMPRESSION SKRAFT	MİNİMUM İ PARÇASI KALINLIĞI MINIMUM WORKPIECE THICKNESS MINDESTENS ICH TEIL DICKE
STD HX-120	193	108	112	17	1500KGF±%5	15MM
STD HX-210	224	133	122	29	2000KGF±%5	25MM
AKSESUARLAR ACCESSORIES VERPACKUNGSDetail	1 adet sıkma kolu, 1 adet 25cmlik bağlantı kolu, 3 lokma, 1 adet allen anahtar 1 piece tightening handle, 1 piece 25cm connecting bar, 3 pieces wrench sockets, 1 piece allen key 1 Stück Spanngriff, 1 Stück 25-cm-Verbindungsstange, 3 Stück Schraubenschlüssel, 1 Stück Inbusschlüssel					
KULLANIM AMACI PURPOSE OF USAGE ZWECK DER NUTZUNG	<p>Manyetik kalıp ayırıcı, işleme operasyonları sırasında iş parçalarını güvenli bir şekilde yerinde tutmak için kullanılan çok yönlü ve etkili bir araçtır. Manyetik kalıp ayırıcı, iş parçasının hızlı ve kolay bir şekilde sıkıştırılmasına olanak tanır ve CNC tezgahlarındaki işleme operasyonları için beş taraftan erişime olanak sağlar.</p> <p>A magnetic vise is a versatile and effective tool used to hold workpieces securely in place during machining operations. The magnetic vise allows quick and easy clamping of the workpiece and allows access from five sides for machining operations on CNC machines.</p> <p>Ein Magnetschraubstock ist ein vielseitiges und effektives Werkzeug, mit dem Werkstücke bei Bearbeitungsvorgängen sicher an Ort und Stelle gehalten werden. Der Magnetschraubstock ermöglicht ein schnelles und einfaches spannen des Werkstücks und ermöglicht den Zugriff von fünf Seiten für Bearbeitungsvorgänge auf CNC-Maschinen.</p>					

STANLEY KAYNAK MAKİNESİ

WELDING MACHINE

SCHWEISSGERÄT

MODEL NUMARASI MODEL NUMBER MODELLNUMMER	WD160IC	ELEKTROD ÇAPI ELECTRODE DIAMETER ELEKTRODEN-DURCHMESSER	1,6 -4,0mm
GİRİŞ VOLTAJİ INPUT VOLTAGE EINGANGSSPANNUNG	230V / 50-60Hz	KORUMA SINIFI PROTECTION CLASS SCHUTZKLASSE	IP21S
GÜÇ POWER ENERGIE	6,9 Kva / 5,2 KW	KORDON UZUNLUĞU CORD LENGTH SCHNURLÄNGE	1,5MT
BOŞTAKİ GERİLİM LOAD VOLTAGE LASTSPANNUNG	60V	KUTU ÖLÇÜLERİ(mm) BOX DIMENSIONS (mm) KASTENABMESSUNGEN (mm)	375X160X310
AKIM ARALIĞI CURRENT RANGE AKTUELLE BEREICH	10 - 60A	KUTU İÇİ AKSESUARLAR BOX ACCESSORIES KASTENZUBEHÖR	Kaynak maskesi, Kaynak fırçası, Elektrot pensi ve Topraklama pensi Welding mask, Welding brush, Electrode clamp and Grounding clamp Schweißmaske, Schweißbürste, Elektrodenklemme und Erdungsklemme
ÇALIŞMA VERİMLİLİĞİ OPERATIONAL EFFICIENCY ARBEITSEFFIZIENZ	20/160A 160A@60%		
DETAY DETAIL DETAIL	<p>Motor bobin sargısı yoktur, elektronik kart sistemi ile çalışmaktadır. Makine içinde küçük bakır sargılı kondansatörler vardır. IGBT (İzole edilmiş kapılı, iki kutuplu transistör) MMA invertör teknolojisine sahiptir. Turbo fanlı sağlam sac gövdeden oluşmaktadır. Hafif, kompakt, düşük tüketime sahip ve güvenilirdir.</p> <p>There is no motor coil winding, it works with the electronic card system. There are small copper-wound capacitors inside the machine. IGBT (Insulated gate, bipolar transistor) has MMA inverter technology. It consists of a solid sheet metal body with a turbo fan. It is light, compact, low consumption and reliable.</p> <p>Es gibt keine Motorspulenwicklung, es funktioniert mit dem elektronischen Kartensystem. In der Maschine befinden sich kleine kupfergewickelte Kondensatoren. IGBT (Insulated Gate, Bipolar Transistor) verfügt über MMA-Wechselrichtertechnologie. Er besteht aus einem massiven Blechkörper mit Turbogebälde. Es ist leicht, kompakt, verbrauchsarm und zuverlässig.</p>		



Değerler milimetre olarak verilmiştir.

Values are given in millimeters.

Werte sind in millimetern angegeben.

STANLEY KAYNAK MAKİNESİ

WELDING MACHINE

SCHWEISSGERÄT

MODEL NUMARASI MODEL NUMBER MODELLNUMMER	WD200IC	ELEKTROD ÇAPI ELECTRODE DIAMETER ELEKTRODEN-DURCHMESSER	1,6 -5,0mm
GİRİŞ VOLTAJİ INPUT VOLTAGE EINGANGSSPANNUNG	230V / 50-60Hz	KORUMA SINIFI PROTECTION CLASS SCHUTZKLASSE	IP21S
GÜÇ POWER ENERGIE	9 Kva / 7 KW	KORDON UZUNLUĞU CORD LENGTH SCHNURLÄNGE	1,5MT
BOŞTAKİ GERİLİM LOAD VOLTAGE LASTSPANNUNG	65V	KUTU ÖLÇÜLERİ(mm) BOX DIMENSIONS (mm) KASTENABMESSUNGEN (mm)	375X160X310
AKIM ARALIĞI CURRENT RANGE AKTUELLE BEREICH	15 - 200A	KUTU İÇİ AKSESUARLAR BOX ACCESSORIES KASTENZUBEHÖR	Kaynak maskesi, Kaynak fırçası, Elektrot pensi ve Topraklama pensi Welding mask, Welding brush, Electrode clamp and Grounding clamp Schweißmaske, Schweißbürste, Elektrodenklemme und Erdungsklemme
ÇALIŞMA VERİMLİLİĞİ OPERATIONAL EFFICIENCY ARBEITSEFFIZIENZ	20/200A 200A@60%		
DETAY DETAIL DETAIL	<p>Motor bobin sargısı yoktur, elektronik kart sistemi ile çalışmaktadır. Makine içinde küçük bakır sargılı kondansatörler vardır. IGBT (izole edilmiş kapılı, iki kutuplu transistör) MMA invertör teknolojisine sahiptir. Turbo fanlı sağlam sac gövdeden oluşmaktadır. Hafif, kompakt, düşük tüketime sahip ve güvenilirdir. LED termal koruma göstergesi mevcuttur.</p> <p>There is no motor coil winding, it works with the electronic card system. There are small copper-wound capacitors inside the machine. IGBT (Insulated gate, bipolar transistor) has MMA inverter technology. It consists of a solid sheet metal body with a turbo fan. It is light, compact, low consumption and reliable. There is an LED thermal protection indicator.</p> <p>Es gibt keine Motorspulenwicklung, es funktioniert mit dem elektronischen Kartensystem. In der Maschine befinden sich kleine kupfergewickelte Kondensatoren. IGBT (Insulated Gate, Bipolar Transistor) verfügt über MMA-Wechselrichtertechnologie. Er besteht aus einem massiven Blechkörper mit Turbogebälde. Es ist leicht, kompakt, verbrauchsarm und zuverlässig. Es gibt eine LED-Thermoschutzanzeige.</p>		



Değerler milimetre olarak verilmiştir.

Values are given in millimeters.

Werte sind in millimetern angegeben.

A close-up photograph of a person's hands working on a dark, textured surface, likely a piece of equipment or a component. The person is using a hand tool, possibly a screwdriver or a similar instrument, to adjust or tighten a part. The background is dark and out of focus, showing a grid pattern and a green-handled tool. The overall scene is well-lit, highlighting the texture of the surface and the precision of the work.

**MANUEL
EL ALETLERİ**
MANUAL
HAND TOOLS

ALLEN ANAHTARLARI

ALLEN KEYS

INBUSSCHLÜSSELE

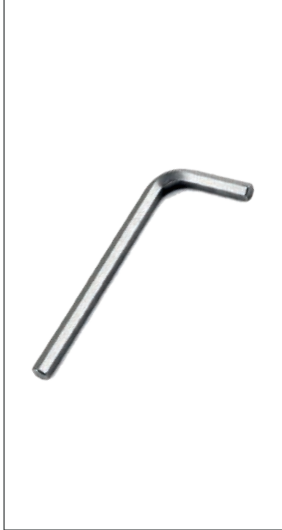

ÖLÇÜLERİ DIMENSIONS MASSE	1,5 MM	2 MM	2,5 MM	3 MM	4 MM	5 MM	6 MM	8 MM
MALZEME MATERIAL MATERIAL	Otomat Çeliği Cutting Steel Schneiden Von Stahl							
KULLANIM USAGE NUTZUNGSZWECK	Altıgen profili olan ve içeri gömük vidaları, imbus başlı civataları sökmeye yarayan anahtar çeşididir. It is a type of wrench that has a hexagonal profile and is used to remove recessed screws and imbus head bolts. Es handelt sich um eine Art Schraubenschlüssel mit Sechskantprofil, der zum Entfernen von Kreuzschlitzschrauben und Imbuskopfschrauben verwendet wird.							

BİTS UÇLAR

BITS INSERTS

BITS-EINSÄTZE

ÖLÇÜLERİ DIMENSIONS MASSE	25mm	50mm	75mm	100mm	150mm	T 30X50	T 30X75	T 30X100
ÇEŞİTLERİ TYPES TYPEN	PZ, PH	PZ, PH	PZ, PH	PZ, PH	PZ, PH	TORX	TORX	TORX
MALZEME MATERIAL MATERIAL	Crv Manyetik Crv Magnetic Crv Magnetisch	Crv Manyetik Crv Magnetic Crv Magnetisch	Crv Manyetik Crv Magnetic Crv Magnetisch	Crv Manyetik Crv Magnetic Crv Magnetisch	Crv Manyetik Crv Magnetic Crv Magnetisch	Crv Manyetik Crv Magnetic Crv Magnetisch	Crv Manyetik Crv Magnetic Crv Magnetisch	Crv Manyetik Crv Magnetic Crv Magnetisch
YÜZEY AUFTAUCHEN SURFACE	Kumlanmış Blasted Gesprengt	Kumlanmış Blasted Gesprengt	Kumlanmış Blasted Gesprengt	Kumlanmış Blasted Gesprengt	Kumlanmış Blasted Gesprengt	Kumlanmış Blasted Gesprengt	Kumlanmış Blasted Gesprengt	Kumlanmış Blasted Gesprengt

TEKNİK ÖLÇÜLERİ

TECHNICAL DIMENSIONS

TECHNISCHE ABMESSUNGEN

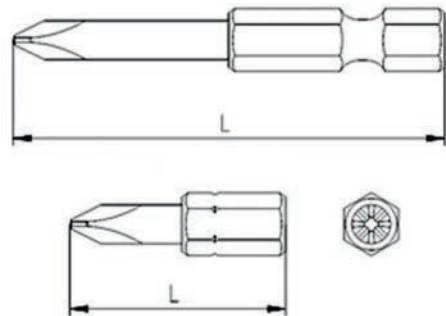

Değerler milimetre olarak verilmiştir.

Values are given in millimeters.

Werte sind in millimetern angegeben.

MAKET BIÇAKLARI

UTILITY KNIFES

MODELL MESSERE

ÜRÜN TANIMI PRODUCT DESCRIPTION PRODUKTBESCHREIBUNG	Plastik maket bıçağı Utility knife plastic body Gebrauchsmesser aus kunststoff	Metal maket bıçağı Utility knife metal body Gebrauchsmesser aus metall
MALZEME MATERIAL MATERIAL	Plastik Plastic Kunststoff	Alüminyum Aluminum Aluminium
RENK COLOUR FARBE	Mavi Blue Blau	Gümüş Gri Silver Grey Silber Grau
BIÇAK BİLGİLERİ KNIFE INFORMATION MESSER INFORMATIONEN	ÜRÜN GÖRSELİ PRODUCT IMAGE PRODUKTBILD	
MALZEME MATERIAL MATERIAL	Karbon Çeliği Carbon Stell Kohlenstoffstahl	
GENİŞLİK WIDTH BREITE	18mm	
KALINLIK THICKNESS DICKE	0,5mm	
UZUNLUK LENGTH LÄNGE	100 mm (0,5x18x100mm)	

MAKET BIÇAK YEDEĞİ

CUTTER BLADE

SCHNEIDMESSER

MALZEME MATERIAL MATERIAL	Krom Kaplama Çelik	
GENİŞLİK WIDTH BREITE	18mm	
KALINLIK THICKNESS DICKE	0,5mm	
UZUNLUK LENGTH LÄNGE	100 mm (0,5x18x100mm)	

Değerler milimetre olarak verilmiştir.

Values are given in millimeters.

Werte sind in millimetern angegeben.









MOBİLYA
AKSESUARLARI
FURNITURE
ACCESSORIES

ÇEKMECE KİLİTLERİ

DRAWER LOCKS

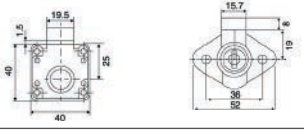
SCHUBLADENSCHLÖSSER

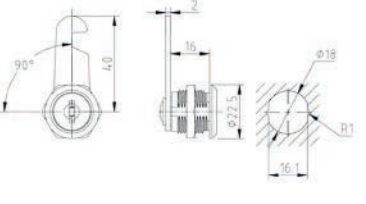
ÜRÜN TANIMI PRODUCT DESCRIPTION PRODUKTBESCHREIBUNG		DETAY DETAIL DETAIL
NO 138-22C	KARE ÇEKMECE KİLİDİ SQUARE DRAWER LOCK QUADRATISCHES SCHUBLADENSCHLOSS	Sac malzemeden yapılmaktadır. Kilit dili demirdir. Arka kısmı, gövde ve iç kapağı çeliktir. Mat nikel kaplamadır. Döndürme açısı saat yönünde 180°dir. 2 kırılabilir anahtarı vardır. It is made of sheet material. The lock tongue is iron. The back, body and inner cover are steel. Matt nickel plated. The rotation angle is 180° clockwise. It has 2 breakable keys.
NO 106C	OVAL ÇEKMECE KİLİDİ OVAL DRAWER LOCK OVALES SCHUBLADENSCHLOSS	Es besteht aus Plattenmaterial. Die Schlosszunge ist aus Eisen. Die Rückseite, der Körper und die innere Abdeckung sind aus Stahl. Matt vernickelt. Der Drehwinkel beträgt 180° im Uhrzeigersinn. Es hat 2 zerbrechliche Schlüssel.
NO 103-16	POSTA KUTUSU KİLİDİ MAILBOX LOCK BRIEFKASTENSCHLOSS	103-16; 103-20 ve 103-25 ölçülerindedir. Kilit göbeği 19mm'dir. Zamak kalıp dökümlü gövdesi ve silindiri vardır. Krom kaplamadır. Döndürme açısı saat yönünde 90 derecedir. 2 kırılabilir anahtarı vardır. 103-16; It is in sizes 103-20 and 103-25. Lock core is 19mm. It has a zamak die-cast body and cylinder. It is chrome plated. The rotation angle is 90 degrees clockwise. It has 2 breakable keys.
NO 103-20		
NO 103-25		103-16; Es ist in den Größen 103-20 und 103-25 erhältlich. Schlosskern ist 19 mm. Gehäuse und Zylinder aus Zamak-Druckguss. Es ist verchromt. Der Drehwinkel beträgt 90 Grad im Uhrzeigersinn. Es hat 2 zerbrechliche Schlüssel.
288-19A-500MM	MERKEZİ ÇEKMECE KİLİDİ	Merkezi gövde çubuğu 2,4 mm kalınlıkta, alüminyum malzemedir. 2 kırılabilir anahtar mevcuttur. The central body bar is 2.4 mm thick, aluminum material. 2 breakable keys are available. Die zentrale Körperstange ist 2,4 mm dickes Aluminiummaterial. 2 abbrechbare Schlüssel sind vorhanden.
288-19A-600MM	CENTRAL DRAWER LOCK	
288-19A-700MM	ZENTRALES SCHUBLADENSCHLOSS	

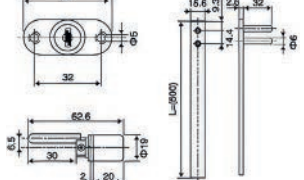
ÜRÜN TANIMI PRODUCT DESCRIPTION PRODUKTBESCHREIBUNG		ÜRÜN GÖRSELİ PRODUCT IMAGE PRODUKTBILD	TEKNİK ÇİZİM TECHNICAL DRAWING TECHNISCHE ZEICHNUNG
NO 138-22C	KARE ÇEKMECE KİLİDİ SQUARE DRAWER LOCK QUADRATISCHES SCHUBLADENSCHLOSS		
NO 106C	OVAL ÇEKMECE KİLİDİ OVAL DRAWER LOCK OVALES SCHUBLADENSCHLOSS		
NO 103-16	POSTA KUTUSU KİLİDİ MAILBOX LOCK BRIEFKASTENSCHLOSS		
NO 103-20			
NO 103-25			
288-19A-500MM	MERKEZİ ÇEKMECE KİLİDİ		
288-19A-600MM	CENTRAL DRAWER LOCK		
288-19A-700MM	ZENTRALES SCHUBLADENSCHLOSS		

Değerler milimetre olarak verilmiştir.

Values are given in millimeters.

Werte sind in millimetern angegeben.

ÇEKMECE RAYLARI

DRAWER SLIDES

SCHUBLADENSCHIENEN

GENİŞLİK WIDTH BREITE	17mm					35mm					43mm				
	UZUNLUK LENGTH LÄNGE	310mm	342mm	406mm	438mm	300mm	350mm	400mm	450mm	500mm	300mm	350mm	400mm	450mm	500mm
AĞIRLIK (grams) WEIGHT (grams) GEWICHT(grams)	230	250	275	330	615	785	900	1020	1150	860	1030	1160	1320	1460	
MALZEME MATERIAL MATERIAL	Dx51 B yüzey galvaniz sac DX51 B surface galvanized sheet DX51 B oberfläche verzinktes blech														
YÜZEY AUFTAUCHEN SURFACE	Kaplamasız Uncoated Unbeschichtet														

TEKNİK ÇİZİM	TECHNICAL DRAWING	TECHNISCHE ZEICHNUNG

Değerler milimetre olarak verilmiştir.

Values are given in millimeters.

Werte sind in millimetern angegeben.

DOLAP ASKI ELEMANLARI

CABINET HANGERS

SCHRANKAUFHÄNGERE

MALZEME MATERIAL MATERIAL	Plastik + DKP Saç Plastic + DKP Sheet Kunststoff + DKP Blatt	
RENK COLOUR FARBE	Beyaz White Weiss	
SAC KALINLIĞI THICKNESS DICKE	1,20M	
TAŞIMA KAPASİTESİ CARRYING CAPACITIES TRAGKAPAZİTÄTEN	80 KG	

GAZLI PİSTONLAR

GAS SPRINGS

GASKOLBENE

ÇEŞİTLERİ TYPES TYPEN	80N	100N	120N	KISA SHORT KURZ			TERS AÇILIR DOWN OPEN UNTEN ÖFFNEN	YAVAŞ KAPANAN SOFT CLOSING SANFTES SCHLIEßEN	
				60N	80N	100N	100N	80N	100N
AĞIRLIK (gram) WEIGHT (grams) GEWICHT (gramm)	130	130	130	100	100	100	100	150	150
RENK COLOUR FARBE	Gri - Beyaz Grey - White Grau - Weiss	Gri - Beyaz Grey - White Grau - Weiss	Gri Grey Grau	Gri Grey Grau	Gri Grey Grau	Gri Grey Grau	Gri Grey Grau	Gri Grey Grau	Gri Grey Grau
UZUNLUK LENGTH LÄNGE	270 mm	270 mm	270 mm	230 mm	230 mm	230 mm	270 mm	270 mm	270 mm
TAŞIMA KAPASİTELERİ CARRYING CAPACITIES TRAGKAPAZİTÄTEN	4 KG	8 KG	10 KG	4 KG	6 KG	8 KG	8 KG	6 KG	8 KG
MALZEME MATERIAL MATERIAL	Çelik gövde. Pirinç yüzük. Steel body. Brass ring. Stahlkörper. Messingring.								

TEKNİK ÖZELLİKLER

TECHNICAL SPECIFICATIONS

TECHNISCHE DATEN

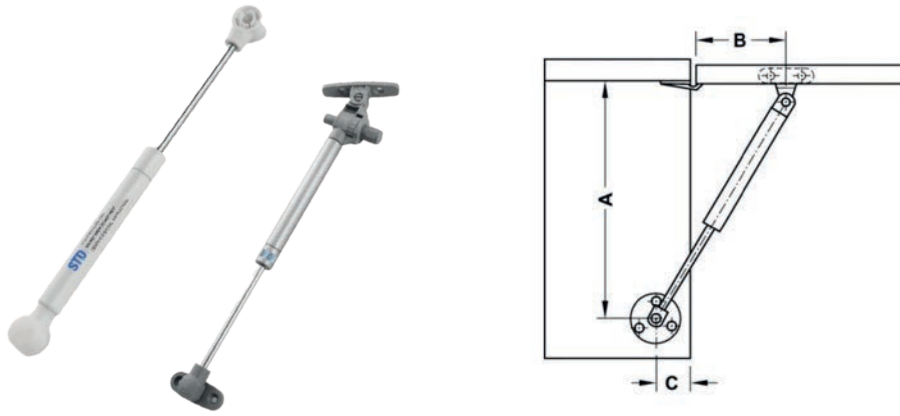

Değerler milimetre olarak verilmiştir.

Values are given in millimeters.

Werte sind in millimetern angegeben.

MENTEŞELER

HINGE

SCHARNIER

ÇEŞİTLERİ TYPES TYPEN	TAS MENTEŞE FLAT HINGE FLACHES SCHARNIER	PİSTONLU MENTEŞE HYDRAULIC HINGE KOLBENSCHARNIER FULL OVERLAY - HALF OVERLAY - INSET	DERECELİ MENTEŞE GRADE HINGE GRADE SCHARNIER 45° - 90° - 135° - 165°	DERECELİ PİSTONLU MENTEŞE GRADE HYDRAULIC HINGE GRADE KOLBENSCHARNIER 45° - 90° - 165°
AĞIRLIK (gram) WEIGHT (grams) GEWICHT (gramm)	62	93	45° 70 g 90° 72 gr 135° 88gr 165° 142gr	45° 106g 90° 106 g 165° 142g
MALZEME MATERIAL MATERIAL	Çelik, nikel kaplı Nickel plated steel Vernickelter stahl			
YÜZEY SURFACE AUFTAUCHEN	Saten nikel Satin nickel Satin nickel			

TEKNİK ÇİZİM

TECHNICAL DRAWING

TECHNISCHE ZEICHNUNG



Değerler milimetre olarak verilmiştir.

Values are given in millimeters.

Werte sind in millimetern angegeben.

GARDROP SÜRGÜ MEKANİZMALARI

WARDROBE SLIDING MECHANISMS

GARDEROBE-GLEITMECHANISMEN

AĞIRLIK (gram) WEIGHT (grams) GEWICHT (gramm)	120 g
TAŞIMA KAPASİTESİ CARRYING CAPACITIES TRAGKAPAZITÄTEN	80 kg
MALZEME MATERIAL MATERIAL	Plastik + DKP Saç Plastic + DKP Sheet Kunststoff + DKP Blatt

TEKNİK ÇİZİM

TECHNICAL DRAWING

TECHNISCHE ZEICHNUNG

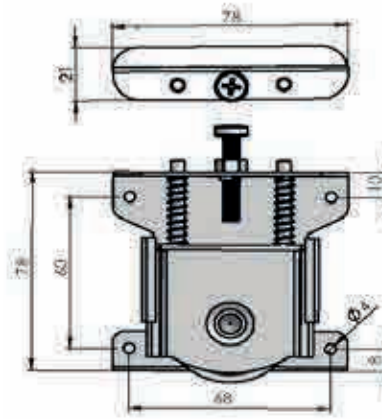
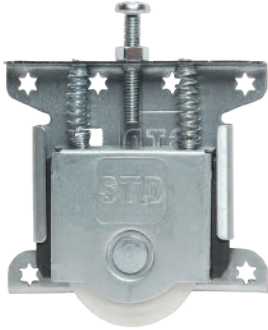

KAPI DÜRBÜNÜ

DOOR VIEWER

TÜRSPIEGEL

Ürün Özellikleri	Product Properties	Produkt Eigenschaften
MALZEME MATERIAL	Çelik Steel Stahl	
RENK COLOUR FARBE	SATEN SATIN	
UZUNLUK LENGTH LÄNGE	60M-90MM	
GÖRÜŞ AÇISI VISUAL ANGLE SICHTWINKEL	180°	
ÇAP DIAMETER DURCHMESSER	25 mm	

KAPAK İTİCİ

PUSH OPEN

AUFSTOSEN

ÇEŞİTLERİ TYPES TYPEN	STD 001 BEYAZ STD 001 WHITE STD 001 WEISS	STD 001 GRİ STD 001 GREY STD 001 GRAU	STD 002 SATEN STD 002 SATIN
ÜRÜN GÖRSELİ PRODUCT IMAGE PRODUKT BILD			
AĞIRLIK (GRAM) WEIGHT (GRAMS) GEWICHT (GRAMM)	170	170	248
UZUNLUK LENGTH LÄNGE	130 mm	130 mm	118 mm
YÜZEY AUFTAUCHEN SURFACE	PLASTİK PLASTIC PLASTIK	PLASTİK PLASTIC PLASTIK	PASLANMAZ ÇELİK STAINLESS STEEL ROSTFREIER STAHL

Değerler milimetre olarak verilmiştir.

Values are given in millimeters.

Werte sind in millimetern angegeben.

MINIFIX GÖVDE

MINIFIX BODY

MINIFIX-KÖRPER

Ürün Özellikleri	Product Properties	Produkt Eigenschaften
AĞIRLIK (GRAM) WEIGHT (GRAMS) GEWICHT (GRAMM)	4,8	
HAMMADDE RAW MATERIAL ROHSTOFF	OTOMAT ÇELİK FREE CUTTING STEEL AUTOMATENSTAHL	
KOLİ İÇİ ADET QUANTITY PER CARTON MENGE PER KARTON	4.000	

MINIFIX DÜBEL

MINIFIX DOVEL

MINIFIX-DÜBEL

Ürün Özellikleri	Product Properties	Produkt Eigenschaften
ÖLÇÜ DIMENSION	M6 8X13	
AĞIRLIK (GRAM) WEIGHT (GRAMS) GEWICHT (GRAMM)	3,6	
HAMMADDE RAW MATERIAL ROHSTOFF	OTOMAT ÇELİK FREE CUTTING STEEL AUTOMATENSTAHL	
KOLİ İÇİ ADET QUANTITY PER CARTON MENGE PER KARTON	6.000	

ÖLÇÜM ALETLERİ

MEASURING
INSTRUMENTS

Mıknatıslı Su Terazisi
Magnetic Spirit Level



STD ŐERİT METRELER

MEASURING TAPE

MASSBAND

ÖLÇÜLERİ DIMENSIONS MASSE	3m*16mm	5m*19mm	5m*25mm
AĞIRLIK (gram) WEIGHT (grams) GEWICHT (gramm)	192	208	283
KASA RENGİ CASE COLOR GEHÄUSEFARBE	Mavi Blue Blau		
KASA KORUMASI CASE PROTECTION KOFFERSCHUTZ	Var Yes Ja		
OTOMATİK STOP ÖZELLİĞİ AUTO STOP FEATURE AUTO-STOP-FUNKTION	Var Yes Ja		
KİLİT ÖZELLİĞİ LOCK FEATURE SPERRFUNKTION	Var Yes Ja		
KEMER TOKASI BELT BUCKLE GÜRTELSCHNALLE	Var Yes Ja		
TAŞIMA İPİ CARRY LINE ÜBERTRAGUNGSLINIE	Var Yes Ja		

Değerler milimetre olarak verilmiştir.

Values are given in millimeters.

Werte sind in millimetern angegeben.

STDeKko ŞERİT METRELER

MEASURING TAPE

MASSBAND

ÖLÇÜLERİ DIMENSIONS MASSE	3m*16mm	5m*19mm	5m*25mm
AĞIRLIK (gram) WEIGHT (grams) GEWICHT (gramm)	88	158	167
KASA RENGİ CASE COLOR GEHÄUSEFARBE	Beyaz White Weiss		
KASA KORUMASI CASE PROTECTION KOFFERSCHUTZ	Yok No Nein		
OTOMATİK STOP ÖZELLİĞİ AUTO STOP FEATURE AUTO-STOP-FUNKTION	Yok No Nein		
KİLİT ÖZELLİĞİ LOCK FEATURE SPERRFUNKTION	Var Yes Ja		
KEMER TOKASI BELT BUCKLE GÜRTELSCHNALLE	Var Yes Ja		
TAŞIMA İPİ CARRY LINE ÜBERTRAGUNGSLINIE	Var Yes Ja		

Değerler milimetre olarak verilmiştir.

Values are given in millimeters.

Werte sind in millimetern angegeben.

SU TERAZİLERİ

SPIRIT LEVELS

WASSERWAAGE

ÖLÇÜLERİ DIMENSIONS MASSE	40CM	50CM	60CM	80CM	100CM
MALZEME MATERIAL MATERIAL	Alüminyum + manyetik özellikli Aluminum + magnetic Aluminium + magnetisch				
AĞIRLIK (gram) WEIGHT (grams) GEWICHT (gramm)	185	226	268	361	377

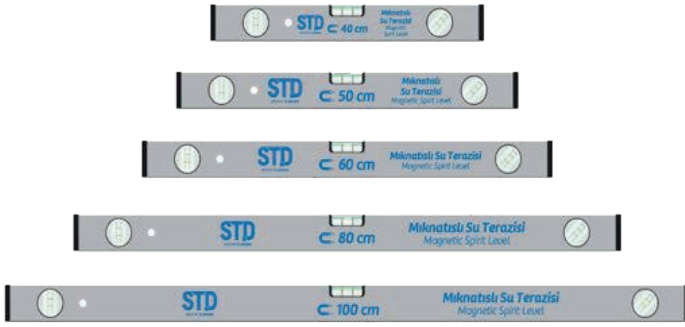
ÜRÜN GÖRSELİ	PRODUCT IMAGE	PRODUKTBILD
		

Değerler milimetre olarak verilmiştir.

Values are given in millimeters.

Werte sind in millimetern angegeben.



**TAŞIMA
KALDIRMA
EKİPMANLARI**

LIFTING AND
HANDLING
EQUIPMENT

SAPANLAR

WEBBING SLINGS

HEBEBANDER





ÖLÇÜLERİ DIMENSIONS MASSE	TON TON TONNE	1 METRE 1 METER 1 METER	2 METRE 2 METER 2 METER	3 METRE 3 METER 3 METER	4 METRE 4 METER 4 METER	5 METRE 5 METER 5 METER	6 METRE 6 METER 6 METER
AĞIRLIK (gram/m ²) WEIGHT (grams/m ²) GEWICHT (gramm/m ²)	1	200	300	400	550	650	—
	2	400	600	850	1050	1250	—
	3	—	900	1250	1600	1950	—
	4	—	1150	1600	2050	2550	3000
	5	—	—	2100	2700	3300	3900
	6	—	—	2500	3220	3950	4650
AMBALAJ DETAYI (Koli içi miktar) PACKING DETAILS (Quantity per Carton) VERPACKUNGSDetail (Menge im Karton)	TON TON TONNE	1 METRE 1 METER 1 METER	2 METRE 2 METER 2 METER	3 METRE 3 METER 3 METER	4 METRE 4 METER 4 METER	5 METRE 5 METER 5 METER	6 METRE 6 METER 6 METER
	1	50	50	40	35	30	—
	2	35	30	25	20	15	—
	3	—	20	15	12	10	—
	4	—	15	12	10	9	6
	5	—	—	8	6	6	6
6	—	—	8	6	5	5	
MALZEME MATERIAL	%100 Polyester						
GÜVENLİK FAKTÖRÜ SAFETY FACTOR SICHERHEITSAKTOR	5:1						
AMBALAJ DETAYI PACKING DETAILS VERPACKUNGSDetail	Her bir malzeme tekli ambalaj ile birlikte gelmektedir. Each item comes with a single shrink. Jedem artikel wird mit einem einzigen schrumpf geliefert.						
KULLANIM AMACI PURPOSE OF USAGE ZWECK DER NUTZUNG	Sapanlar yüklerin kaldırılması ve indirilmesini sağlayan hafif, malzemeye zarar vermeyen, polyesterden örülmüş malzemelerdir. Web slings are lightweight, non-damaging, polyester knitted materials that enable lifting and lowering of loads. Hebebänder sind leichte, schonende Polyester-Strickmaterialien, die das Heben und Senken von Lasten ermöglichen.						



STD ŞİŞME TEKERLER

INFLATABLE WHEELS

AUFBLASBARE RÄDER

ÇEŞİTLERİ TYPES TYPEN	Metal jant Şişme teker Metal rim Pneumatic wheel Lufrtrad mit Metallfelge	Plastik jant Şişme teker Plastic rim Pneumatic wheel Kunststofffelge Lufrtrad	Pu teker Pu wheel Pu-rad	İç teker Inner wheel Inneres rad
MALZEME MATERIAL	Kauçuk Rubber Gummi	Kauçuk Rubber Gummi	Kauçuk Rubber Gummi	Kauçuk Rubber Gummi
JANT RIM FEDGE	Galvanized Sheet	Plastic	Galvanized Sheet	-
AĞIRLIK (gram) WEIGHT (grams) GEWICHT (gramm)	2,15 kg	2 kg	2,15 kg	0,3 kg
TAŞIMA KAPASİTESİ CARRYING CAPACITIES TRAGKAPAZITÄTEN	110 kg	110 kg	110 kg	-
BASINÇ (BAR) PRESSURE (BAR) DRUCK (BAR)	1,38	1,38	1,38	-
SAC KALINLIĞI THICKNESS DICKE	1 mm	-	1 mm	-
TEKERLEK ÇAPI WHEEL DIAMETER RADDURCHMESSER	345 mm	345 mm	345 mm	-
TEKERLEK GENİŞLİĞİ WHEEL WIDTH RADBREITE	77 mm	77 mm	77 mm	-
JANT ÇAPI WHEEL DIAMETER RADDURCHMESSER	205 mm	205 mm	205 mm	-
RULMAN İÇ ÇAP BEARING INSIDE DIAMETER LAGERINNENDURCHMESSER	20 mm	20 mm	20 mm	-
ÜRÜN GÖRSELİ PRODUCT IMAGE PRODUKTBILD				

Değerler milimetre olarak verilmiştir.

Values are given in millimeters.

Werte sind in millimetern angegeben.

TRANSPALETLER

PALLET TRUCKS

HUBWAGENE

ÇEŞİTLERİ TYPES TYPEN	Ce belgeli Ce certified Ce-zertifiziert	Ce belgesiz Without ce certificate Ohne ce-zertifikat
SAC KALINLIĞI THICKNESS DICKE	3 mm	3,75 mm
TEKERLEK WHEEL RAD	Beyaz White Weiss	Kırmızı RED ROT
TEKERLEK MALZEME WHEEL MATERIAL RAD MATERIAL	Polyamid teker Polyamide wheel Polyamid-rad	Polyamid üzeri poliüretan kaplı teker Polyurethane coated wheel on polyamide Polyurethanbeschichtete räder auf polyamid
RENK COLOUR FARBE	Sarı Yellow Gelb	
TAŞIMA KAPASİTESİ CARRYING CAPACITIES TRAGKAPAZITÄTEN	2500 kg	
TEK ÇATAL GENİŞLİĞİ SINGLE FORK WIDTH EINZELNE GABELBREITE	160 mm	
MİNİMUM ÇATAL YÜKSEKLİĞİ MINIMUM FORK HEIGHT MINDESTGABELHÖHE	85 mm	
MAKSİMUM ÇATAL YÜKSEKLİĞİ MAXIMUM FORK HEIGHT MAXIMALE GABELHÖHE	200 mm	



KOLİ TAŞIMA ARABASI

FOLDING UTILITY WAGON

ZUSAMMENKLAPPBARER NUTZWAGEN

MODEL MODEL MODELL	AÇIK POZİSYON ÖLÇÜLERİ (cm) OPEN POSITION DIMENSIONS (cm) POSITIONSABMESSUNGEN OFFNEN (cm)	KAPALI POZİSYON ÖLÇÜLERİ (cm) CLOSED POSITION DIMENSIONS (cm) ABMESSUNGEN DER GESCHLOSSENEN POSITION (cm)	TAŞIMA KAPASİTESİ (kg) CARRYING CAPACITY (kg) TRAGKAPAZITÄT (kg)	TEKER DETAYI WHEEL DETAIL RADEDETAIL
STD KOLİ TAŞIMA ARABASI	87 X 55 X 57	75 X 55 X 21	80	8 X 1,75 PVC
AÇIKLAMA DESCRIPTION BESCHREIBUNG	<p>Çelik çerçeveye üretilmiş ve sağlam bir kumaş astarla kapatılmış portatif katlanır yük taşıma arabasıdır. Dört sağlam tekerleğe sahiptir ve daha fazla kullanıcı konforu için yumuşak kavramalı bir kola sahiptir. Maksimum 80 kg yük kapasitelidir.</p> <p>It is a portable folding cargo trolley manufactured with a steel frame and covered with a sturdy fabric lining. It has four sturdy wheels and is attached to a soft-grip handle for greater user comfort. It has a maximum load capacity of 80 kg.</p> <p>Es handelt sich um einen tragbaren, zusammenklappbaren Lastenwagen mit einem Stahlrahmen und einer stabilen Stoffauskleidung. Er verfügt über vier stabile Räder und ist für mehr Benutzerkomfort an einem Softgrip-Griff befestigt. Die maximale Tragfähigkeit beträgt 80 kg.</p>			
KULLANIM AMACI PURPOSE OF USAGE ZWECK DER NUTZUNG	<p>Yük taşıma, bahçe işleri, kamp, barbekü, festivaller, piknikler, parkta oyun ve alışveriş gibi tüm aile ve tüm dış mekan aktiviteleri için idealdir. Bu katlanır araba, birçok mevsime dayanacak kadar dayanıklı, güçlü ve sağlam, yüksek kaliteli malzemeden yapılmıştır. Hafif, taşınabilir ve yüksek esnekliğe sahiptir. Montajı ve sökülmesi kolaydır. Yer kaplamadan katlanabilir, saklanabilir ve depolanabilir.</p> <p>Ideal for the whole family and all outdoor activities such as carrying loads, gardening, camping, barbecues, festivals, picnics, playing in the park and shopping. This folding stroller is made of high quality material, strong and sturdy, durable enough to withstand many seasons. It is lightweight, portable and highly flexible. It is easy to assemble and disassemble. It can be folded, stored and stored without taking up space.</p> <p>Ideal für die ganze Familie und alle Outdoor-Aktivitäten wie Lastentragen, Gartenarbeit, Camping, Grillen, Festivals, Picknicks, Spielen im Park und Einkaufen. Dieser faltbare Kinderwagen besteht aus hochwertigem Material, ist stark und robust und langlebig genug, um vielen Jahreszeiten standzuhalten. Es ist leicht, tragbar und äußerst flexibel. Es ist einfach zu montieren und zu demontieren. Es kann zusammengeklappt, verstaut und verstaut werden, ohne Platz zu beanspruchen.</p>			

Değerler milimetre olarak verilmiştir.

Values are given in millimeters.

Werte sind in millimetern angegeben.



**TEKNİK
KİMYASALLAR**
TECHNICAL
CHEMICALS

KİMYASAL DÜBELLER

CHEMICAL ANCHORS

CHEMISCHER ANKER

ÇEŞİTLERİ TYPES TYPEN	345ml	410ml	
MALZEME MATERIAL MATERIAL	Polyester reçine bazlıdır.		
SICAKLIK ARALIĞI TEMPERATURE RANGE TEMPERATURBEREICH	-40°C +120°C	-40°C +120°C	
SERTİFİKASYON CERTIFICATION ZERTIFIZIERUNG	CE, TSE		
RAF ÖMRÜ SHELF LIFE HALTBARKEIT	18 Ay 18 Months 18 Monate		
UYGULAMA ALANLARI USAGE AREAS EINSATZBEREICHE	Beton, mermer, taş vb. ankraj ve yapıştırma işlerinde, makine ve sistemlerin ankraj ve montaj işlerinde kullanılır. Concrete, marble, stone etc. It is used in anchoring and bonding works, anchoring and assembly works of machines and systems. Beton, Marmor, Stein etc. Es wird bei Verankerungs- und Klebearbeiten, Verankerungs- und Montagearbeiten von Maschinen und Anlagen eingesetzt.		

POLIÜRETAN KÖPÜK

POLYURETHANE FOAM

POLYURETHANSCHAUM











Ürün Özellikleri	
Hızlı Uygulama	
Ekstra Formül	
Çok Amaçlı	
Product Properties	
Quick Application	
Extra Formula	
Multipurpose	
Produkt Eigenschaften	
Schnelle Anwendung	
Zusätzliche Formel	
Mehrzweck	
Raf Ömrü Shelf life Haltbarkeit	12 ay / 12 month / 12 Monate
Ağırlık Weight Gewicht	600 g
Kullanım Alanı Usage Area Einsatzbereich	Kapı pencere montajı, Boşluk doldurma, Ses ve Isı izolasyon Door and window installation, Gap filling, Sound and Heat insulation Tür- und Fenstereinbau, Fugenfüllung, Schall- und Warmedämmung

SİLİKON VE EPOKSİ TABANCI

SILICONE AND EPOXY GUNS

SILIKON UND EPOXIDPISTOLE

ÇEŞİTLERİ TYPES TYPEN	SİLİKON PLASTİK SILICONE PLASTIC SILIKON KUNSTSTOFF	SİLİKON METAL SILICONE METAL SILIKON-METALL	EPOKSİ 345 ml EPOXY 345 ml EPOXID 345 ml	EPOKSİ 410 ml EPOXY 410 ml EPOXID 410 ml
AĞIRLIK (gram) WEIGHT (grams) GEWICHT (gramm)	265	533	664	810
MALZEME MATERIAL	Plastik Plastic Kunststoff	Metal Metall	Metal Metall	Metal Metall
TEK BASKIDA İLERLEYİŞİ PROGRESS IN ONE PRINT FORTSCHRITT IN EINEM DRUCK	8 - 10 mm	5 - 7 mm	5 - 7 mm	5 - 7 mm
RENK COLOUR FARBE	Siyah Black Schwarz	Siyah Black Schwarz	Siyah Black Schwarz	Siyah, kırmızı Black, red Schwarz, rot
TEKNİK ÇİZİM TECHNICAL DRAWING TECHNISCHE ZEICHNUNG				
ÜRÜN GÖRSELİ PRODUCT IMAGE PRODUKTBILD				

SİLİKONİZE MASTİK

SILICONE SEALANT

SILIKON DICHTUNGSMITTEL



Ürün Özellikleri

- Hızlı Uygulama
- Kuvvetli Sızdırmazlık
- UV Işınlara Dayanıklı

Product Properties

- Quick Application
- Strong Sealing
- UV Resistant

Produkt Eigenschaften

- Schnelle Anwendung
- Starke Versiegelung
- UV, beständig

Raf Ömrü
Shelf life
Haltbarkeit

12 ay / 12 month / 12 Monate

Ağırlık
Weight
Gewicht

500 g

Kullanım Alanı
Usage Area
Einsatzbereich

Alüminyum, Cam, Seramik, Metal
Aluminium, Glass, Ceramic, Metal
Aluminium, Glas, Keramik, Metall



Ürün Özellikleri	
Hızlı Uygulama	
Kuvvetli Sızdırmazlık	
UV Işınlara Dayanıklı	
Product Properties	
Quick Application	
Strong Sealing	
UV Resistant	
Produkt Eigenschaften	
Quick Application	
Strong Sealing	
UV Resistant	

Raf Ömrü Shelf life Haltbarkeit	12 ay / 12 month / 12 Monate
Ağırlık Weight Gewicht	300 g
Kullanım Alanı Usage Area Einsatzbereich	Alüminyum, Cam, Seramik, Banyo, Mutfak Aluminium, Glaskeramik, Bad, Küche Aluminum, Glass, Ceramic, Bathroom, Kitchen

SPREY BOYALAR



Ölçü Dimension Messung	Ağırlık Weight Gewicht
400 ml	320 g



HIZLI YAPIŐTIRICI

SUPER GLUE

SEKUNDENKLEBER

ÜRÜN TANIMI PRODUCT DESCRIPTION PRODUKTBESCHREIBUNG	STD 801	
AĞIRLIK (gram) WEIGHT (grams) GEWICHT (gramm)	20 g	
SICAKLIK ARALIĐI TEMPERATURE RANGE TEMPERATURBEREICH	-54°C +82°C	
RENK COLOUR FARBE	Saydam Transparent	
NİHAİ ÇEKME KUVVETİ (N/mm) ENDGÜLTİGE ZUGKRAFT (N/mm) FINAL TENSILE FORCE (N/mm)	~200	
VİSKOZİTE (Cp) VISCOSITY (Cp) VISKOSITÄT (Cp)	2 - 5	

İLK TUTUŐ SÜRESİ	FIRST HOLD TIME	ERSTES HALTEN MAL
KAUÇUK İLE KAUÇUK RUBBER WITH RUBBER GUMMI MIT GUMMI		< 3 saniye < 3 second < 3 zweite
PLASTİK İLE PLASTİK KUNSTSTOFF MIT KUNSTSTOFF PLASTIC WITH PLASTIC		< 5 saniye < 5 second < 5 zweite
METAL İLE METAL METAL WITH METAL METALL MIT METALL		< 10 saniye < 10 second <10 zweite